

**Makita**®

# 2022

Katalóg strojov Makita

Platný od 1. 4. 2022 do 30. 9. 2022



# Sortiment aku strojov do záhrady

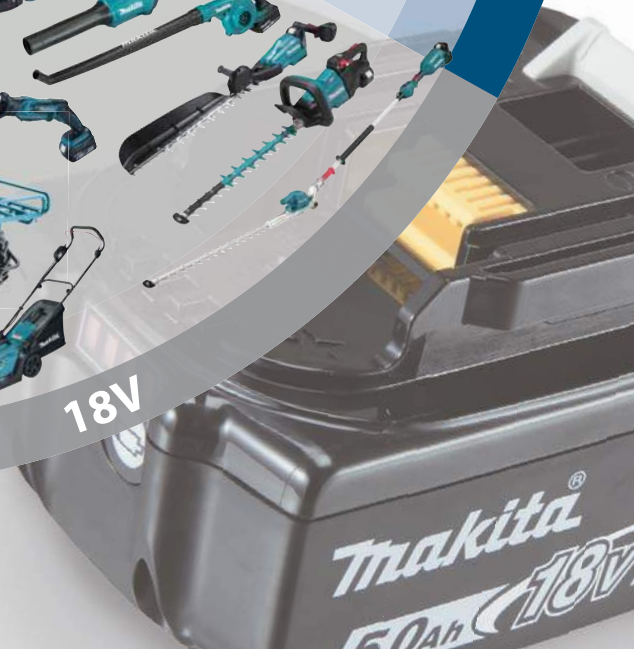
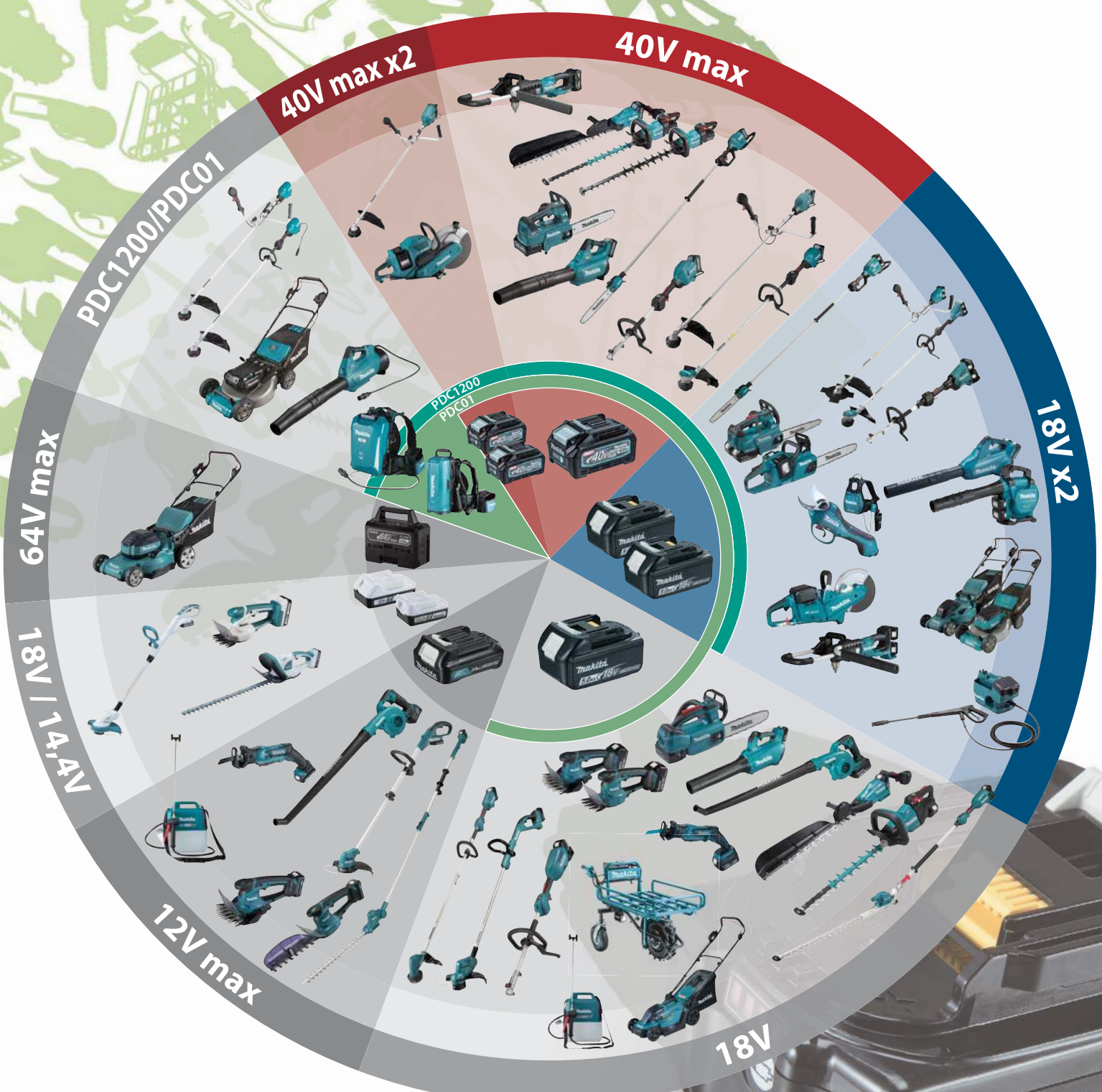



# LI-ION AKUMULÁTORY A NABÍJAČKY

40Vmax 18V		Fast Charging DC40RA DC40RB*	DC40RC	Fast Charging DC40RA + ADP10 Kompatibilné s LXT	DC40RC + ADP10 Kompatibilné s LXT	Fast Charging DC18RC DC18RD* DC18RE**	DC18SF Except BL1430A	DC18SD DC18SH* DC18SE (Automotive)	
<b>XGT</b>  40Vmax Lithium-ion	8,0Ah BL4080F	76min.	170min.	-	-	-	-	-	
	5,0Ah BL4050F	50min.	85min.	-	-	-	-	-	
	4,0Ah BL4040	45min.	67min.	-	-	-	-	-	
	2,5Ah BL4025	28min.	38min.	-	-	-	-	-	
	2,0Ah BL4020	22min.	30min.	-	-	-	-	-	
<b>LXT</b>  18V Lithium-ion	6,0Ah BL1860B	-	-	40min.	85min.	55min.	1 do 2 aku 130 min.	3 do 4 aku 260 min.	130min.
	5,0Ah BL1850B	-	-	35min.	70min.	45min.	110 min.	220 min.	110min.
	4,0Ah BL1840B	-	-	29min.	58min.	36min.	90 min.	180 min.	90min.
	3,0Ah BL1830B	-	-	22min.	42min.	22min.	60 min.	120 min.	60min.
	2,0Ah BL1820B	-	-	24min.	33min.	24min.	45 min.	90 min.	45min.
	1,5Ah BL1815N	-	-	15min.	22min.	15min.	30 min.	60 min.	30min.
<b>CXT</b>  12Vmax Lithium-ion	4,0Ah BL1041B	60min.	130min.	 40Vmax Lithium-ion  18V x2 Lithium-ion		 40Vmax Lithium-ion 18V x2 Lithium-ion 18V Lithium-ion		Možné použitie so 4 ks 18V LXT aku	
	2,0Ah BL1021B	30min.	70min.						
	1,5Ah BL1016	22min.	50min.						
<b>64Vmax</b> Lithium-ion	4,0Ah BL6440	120min.	10,8V Lithium-ion	1,3Ah BL1013	50min.	18V Lithium-ion	1,5Ah BL1415G BL1815G	70 min.	80 min.
			7,2V Lithium-ion	1,5Ah BL0715			35min.		

\*DC40RB / DC18RD / DC18SH: Dvojnabíjačka

\*\*DC18RE: CXT & LXT Duálna nabíjačka

# OBSAH

<b>#</b>									
2712	133	AS001GA101	10	DA4000LR	95	DCU180Z + 199008-0	25	DEBDML801	72
3711	141	AS001GZ	10	DBM080	96	DCU180Z + 199009-8	25	DEBDML806	73
3712	142	AT1150A	149	DBM130	96	DCV202Z2XL	77	DEBDML815	73
4326	137	AT2550A	149	DBM131	96	DCV202ZL	77	DF001DW	86
4327	137	AT638A	149	DBM230	96	DCW180Z	63	DF001GM201	8
4329	137	<b>B</b>		DBM230 + P-54190	161	DDA350Z	43	DF001GZ01	8
6408	94	BO3710	129	DBO180Z	50	DDA351Z	43	DF002GA201	9
6412	94	BO3711	129	DBO380RTJ	50	DDA450RTE	50	DF002GZ	9
6413	94	BO4555	129	DBO380Z	50	DDA450ZK	50	DF012DSE	86
9031	127	BO4557	130	DBO381ZU	50	DDA460Z	26	DF0300	94
9032	127	BO4565K	129	DBO480RTJ	51	DDF083Z	37	DF032DSAE	65
9046	129	BO4900VJ	129	DBO480Z	51	DDF453RFE	37	DF032DSME	65
9741	128	BO5030	130	DBS180Z	51	DDF453RFE + DLC180Z	160	DF032DZ	65
9903	128	BO5031	130	DCB200A	77	DDF453SFX1	37	DF033DSAE	65
9910	127	BO5041	130	DCC500RTE	47	DDF453SYE	37	DF033DZ	65
9911	127	BO6030	130	DCC500Z	47	DDF453SYX4	37	DF332DSAE	65
1806B	140	BO6050J	130	DCE090ZX1	25	DDF453SYX5	37	DF332DSME	65
1911B	140	<b>C</b>		DCF102Z	76	DDF458RF3J	36	DF332DZ	65
2012NBX	141	CA5000XJ	116	DCF201Z	76	DDF458Z	36	DF333DSAE	65
2704N	134	CB100DA	77	DCF203Z	76	DDF482RFEB	36	DF333DSAE + CL108FDZ	161
4100KB	114	CC301DSMJ	68	DCF301Z	76	DDF482RFJ	36	DF333DSAP1	65
4112HS	114	CC301DZ	68	DCG180RF	58	DDF482Z	36	DF333DSME	65
4350FCTJ	136	CE001GZ	8	DCG180Z	58	DDF484RFJ	36	DF333DZ	65
4351FCTJ	137	CF002GZ	16	DCJ205ZL	77	DDF484Z	36	DF488D002	87
5103R	136	CF101DZ	70	DCJ205ZM	77	DDF485RAJ	37	DF488DWAE	87
5143R	136	CG100DSAA	70	DCJ205ZXL	77	DDF485RFJ	37	DFL063FZ	91
5903R	135	CL001GZ	16	DCJ206ZL	77	DDF485RFJ + 632G12-3	160	DFL083FZ	92
7104L	143	CL002GZ01	16	DCJ206ZM	77	DDF485RTJ	37	DFL204FZ	92
9237CB	122	CL070DS	85	DCJ206ZXL	77	DDF485Z	37	DFL301FZ	92
9403J	128	CL106FDWM	85	DCL180Z	84	DDF486RTJ	36	DFL302FZ	91
9404J	128	CL107FDZ	85	DCL180Z + 195584-2 + 632F01-2	160	DDF486Z	36	DFL402FZ	92
9557HNRG	119	CL108FDSAP	85	DCL181FZW	84	DDF487RAJ	37	DFN350RFJ	58
9558HNRG	119	CL108FDWA	85	DCL182Z	84	DDF487Z	37	DFN350Z	58
9558HNRGK	119	CL108FDZ	85	DCL184Z	84	DDG460ZX7	33	DFR452Z	44
9565CR	118	CL114FDWIX	85	DCL280FZ	84	DEADML802	72	DFR550RFE	44
9565CVR	118	CL121DSA	85	DCL501Z	86	DEADML802	73	DFR550Z	44
9924DB	128	CL121DZ	85	DCM501Z	76	DEADML805	71	DFR551RTJ	44
<b>A</b>		CP100DWA	69	DCO181Z	57	DEADML808	73	DFR551Z	44
AC310H	147	CS002GZ	14	DCS552RTJ	46	DEAML103	74	DFS251RTJ	44
AF353	149	CV102DZ2XL	69	DCS552Z	46	DEAML104	72	DFS251Z	44
AF506	149	CV102DZXL	69	DCS553RTJ	46	DEAML105	72	DFS452Z	44
AN454	148	CW001GZ	18	DCS553Z	46	DEAML106	72	DFT023FMZ	90
AN902	148	<b>D</b>		DCU180Z	25	DEBDML186	74	DFT024FMZ	90
AN924	148	DA001GZ	10					DFT025FMZ	90
AN943K	148	DA3010F	95					DFT045FZ	90
AN960	148	DA332DSAE	65					DFT060FMZ	90
		DA333DSAE	65						



DFT085FMZ	91	DHR202RTJ	45	DKP181ZU	54	DPO500Z	56	DTW1001Z	40
DFT120TZ	91	DHR202Z	45	DKT360Z	63	DPO600RTE	56	DTW1002RTJ	41
DFT127FZ	91	DHR241RTJ	45	DLM330ST	36	DPO600Z	56	DTW1002Z	41
DG001GM105	22	DHR241Z	45	DLM330Z	36	DPP200ZK	56	DTW181RTJ	42
DG001GZ05	22	DHR243RTJW	45	DLM382CM2	31	DPT353RFJ	58	DTW181Z	42
DGA452RTJ	49	DHR243Z	45	DLM382PT2	31	DPT353Z	58	DTW190JX3	42
DGA452Z	49	DHR263PT2J	27	DLM382Z	31	DPV300RTJ	56	DTW190RFJ	42
DGA504RTJ	49	DHR263Z	27	DLM432PT2	31	DPV300Z	56	DTW190Z	42
DGA504ZJ	49	DHR280PT2J	27	DLM432Z	31	DRC200Z	84	DTW251RTJ	41
DGA506RTJ	49	DHR280Z	27	DLM465Z	31	DRC300Z	84	DTW251Z	41
DGA506ZJ	49	DHR282T2JU	26	DLM480CT2	31	DRT50RTJX2	57	DTW300RTJ	41
DGA511RFJ	48	DHR282ZU	26	DLM480Z	31	DRT50ZJX2	57	DTW300Z	41
DGA511Z	48	DHR400ZKUN	26	DLM481CT2	32	DRT50ZX4	57	DTW301RTJ	41
DGA513RTJ	48	DHS660RTJ	51	DLM481Z	32	DRV150RFJ	55	DTW301Z	41
DGA513ZJ	48	DHS660ZJ	51	DLM532ZX2	32	DRV150ZJ	55	DTW700RTJ	41
DGA518ZJU	49	DHS661RTJU	52	DLM533ZX2	32	DRV250RFJ	54	DTW700Z	41
DGA519Z	48	DHS661ZJU	52	DLM537Z	32	DRV250ZJ	54	DUA300Z	30
DGA521ZX1	48	DHS680RTJ	52	DLM538CT2	32	DS4012	95	DUA301Z	30
DGA900PT2	25	DHS680Z	52	DLM538Z	32	DSC102Z	46	DUB184RT	63
DGA900Z	25	DHS710PT2J	28	DLM539CT2	32	DSC163ZK	46	DUB184Z	63
DGA901T2U1	25	DHS710Z	28	DLM539Z	32	DSC251ZK	47	DUB185Z	57
DGA901ZUX1	25	DHS782PT2J	27	DLS211ZU	27	DSD180Z	54	DUB186Z	58
DGD800RTJ	50	DHS782Z	27	DLW140Z	28	DSL801RTEU	49	DUB361Z	29
DGD800Z	50	DHS783T2JU	27	DLX2153TJ1	160	DSL801ZU	49	DUB362Z	29
DGP180Z	56	DHS783ZU	27	DLX2153TJ1 + TR00000001	161	DSP600ZJ	28	DUB363PT2V	29
DHG180ZK	55	DHS900ZU	27	DLX2349J	160	DSP601ZJU	28	DUB363ZV	29
DHG181RT	55	DHW080ZK	29	DLX3078TX1	160	DSS610Z	52	DUC254Z	59
DHG181ZK	55	DJN161RFJ	47	DML809	74	DST221Z	59	DUC306PT2B	25
DHK180ZJ	46	DJN161Z	47	DML810	73	DTD152RTJ	40	DUC306ZB	25
DHP453RFE	38	DJR183RTJ	53	DML812	74	DTD152Z	40	DUC353Z	26
DHP453RFX8	38	DJR183Z	53	DML814	74	DTD153RFJ	40	DUC355PT2	26
DHP453SYE	38	DJR186RTE	53	DMP180Z	43	DTD153Z	40	DUC355Z	26
DHP458RTJ	38	DJR186Z	53	DMP181Z	43	DTD154RTJ	40	DUH502RT	59
DHP458Z	38	DJR187RTE	53	DMR108N	81	DTD154Z	40	DUH502Z	59
DHP482RFJ	38	DJR187Z	53	DMR110N	81	DTD156RTJ	39	DUH523Z	59
DHP482Z	38	DJR188RTJ	54	DMR112	80	DTD156Z	39	DUH601PTE	60
DHP484RFJ	38	DJR188Z	54	DMR114	80	DTD157Z	39	DUH601Z	60
DHP484Z	38	DJR360PT2	28	DMR115	80	DTD171RTJ	39	DUH602RT	60
DHP485RF3J	38	DJS131Z	47	DMR116	80	DTD171Z	39	DUH602Z	60
DHP485RFJ	38	DJS200Z	47	DMR202	82	DTD172RTJ	39	DUH651Z	31
DHP485RFJ + DTD171Z	160	DJS800Z	48	DMR203	81	DTD172Z	39	DUH751PTE	60
DHP485Z	38	DJV180Z	53	DMR301	81	DTL063RTJ	43	DUH751Z	60
DHP486RTJ	37	DJV181RTJ	53	DP2010	94	DTM51RFJX1	51	DUH754SZ	60
DHP486Z	37	DJV181Z	53	DP4003	95	DTM51Z	51	DUM111SYX	63
DHP487RAJ	39	DJV182Z	52	DP4010	95	DTM52RFJX1	51	DUM111ZX	63
DHP487Z	39	DJV184RTJ	52	DP4011	95	DTM52Z	51	DUM604RF	62
DHR171RTJ	45	DJV184Z	52	DPB182Z	55	DTR180ZJ	42	DUM604ZX	62
DHR171Z	45	DK0053G	160	DPB183Z	55	DTR181RTJ	42	DUN461WSF	61
DHR182RTJ	45	DKP180RTJ	54	DPJ180Z	57	DTR181ZJ	42	DUN461WZ	61
DHR182Z	45	DKP180Z	54			DTS141Z	40	DUN500WZ	60
		DKP181Z	54			DTW1001RTJ	40	DUP362PT2	30

DUP362Z	30	<b>G</b>	HG6030K	150	HR005GM202	12	HS011GZ	14	
DUR181Z	62	GA005GD201	10	HG6031VK	150	HR005GZ01	12	HS0600	136
DUR189Z	62	GA005GM201	10	HG6530VK	150	HR006GZ	8	HS301DSME	69
DUR190LZX3	61	GA005GZ01	10	HG6531CK	150	HR007GM201	12	HS301DZ	69
DUR190UZX3	61	GA023GM201	11	HK1820	111	HR007GZ	12	HS6101J	134
DUR191LZX3	61	GA023GZ	11	HM001GM201	13	HR140DSMJ	68	HS6601	134
DUR191UZX3	61	GA029GM201	11	HM001GZ02	13	HR140DZ	68	HS6601J	134
DUR192LZ	61	GA029GZ	11	HM002GZ03	8	HR166DSMJ	68	HS6601J + 197462-2 + 199141-8	161
DUR193RF	61	GA035GZ	11	HM0870C	107	HR166DZ	68	HS7100	135
DUR193Z	61	GA036GZ	11	HM0871C	107	HR1840	102	HS7101	135
DUR194ZX1	62	GA038GM201	11	HM1101C	108	HR2300	102	HS7601	135
DUR368APT2	30	GA038GT201	11	HM1111C	108	HR2470	103	HS7611J	135
DUR368AZ	30	GA038GZ	11	HM1203C	108	HR2470BX40	103	HW102	158
DUR369AZ	29	GA4530R	119	HM1205C	108	HR2470T	103	HW111	158
DUS054Z	63	GA5021C	118	HM1213C	108	HR2600	104	HW1200	158
DUT130RTE	43	GA5030R	119	HM1214C	109	HR2630	103	HW1300	158
DUT130Z	43	GA5030RSP4	119	HM1307C	109	HR2630 + GA5030R	161	HW132	158
DUX18ZX1	62	GA5030RX1	119	HM1307CB	109	HR2630T	103	HW151	158
DUX60ZM4	30	GA5050R	118	HM1317C	109	HR2630T + GA9060R	161	<b>J</b>	
DVC150LZ	82	GA5080RX02	119	HM1317CB	109	HR2630X7	103	JN1601	116
DVC155LZX2	82	GA6021	119	HM1501	110	HR2631F	103	JN3201J	116
DVC157LZX3	82	GA6021C	118	HM1502	110	HR2631FT	103	JR001GM201	13
DVC261ZX11	83	GA6040C01	118	HM1511	110	HR2641	103	JR001GZ	13
DVC265ZXU	83	GA7020	121	HM1512	110	HR2652	103	JR002GM201	13
DVC560Z	83	GA7082	122	HM1802	110	HR2800	104	JR002GZ	13
DVC660Z	83	GA9020	121	HM1812	111	HR2810	104	JR103DSAE	70
DVC665ZU	83	GA9020K	121	HP001GM201	9	HR2810T	104	JR103DSME	70
DVC750LZX1	82	GA9020RF	121	HP001GZ01	9	HR2811FT	104	JR103DZ	70
DVP180Z	57	GA9020RFK	121	HP002GA201	9	HR3001CJ	105	JR105DSME	70
DVR450RTE	58	GA9030X01	120	HP002GZ	9	HR3011FCJ	105	JR105DZ	70
DVR450Z	58	GA9040R	119	HP0300	94	HR3012FCWJ	105	JR3051TK	137
DWD181ZJ	59	GA9040RF01	119	HP1630K	101	HR3200C	105	JR3061T	138
DWR180RA	42	GA9050R	122	HP1631K	101	HR3210C	105	JR3070CT	138
DWR180Z	42	GA9060R	120	HP1640K	101	HR3210FCT	105	JS1000	115
DWT310ZK	33	GA9062R	120	HP1641K1X	101	HR3540C	106	JS1601	115
<b>E</b>		GA9070X1	120	HP2050HJ	102	HR4002	106	JS1602	115
ELM3320	154	GA9071X1	120	HP2051HJ	102	HR4003C	106	JS3201J	116
ELM3720	154	GA9080X1	121	HP2070J	101	HR4013C	106	JV0600K	137
ELM4120	154	GA9081	121	HP2071J	101	HR4501C	107	JV101DSME	70
ELM4121	154	GA9082	121	HP332DSAE	65	HR4511C	106	JV101DZ	70
ELM4620	154	GB602	126	HP332DSME	65	HR5202C	107	JV103DSMJ	69
ELM4621	155	GB602W	127	HP332DZ	65	HR5212C	107	JV103DZ	69
<b>F</b>		GB801	127	HP333DSAE	65	HR5212C + DMR108N	161	<b>K</b>	
FN001GA201	16	GD0601	125	HP333DZ	65	HS004GM202	13	KC100	143
FN001GZ	16	GD0603	125	HP488D002	86	HS004GZ01	13	KP001GM202	15
FS2300	97	GD0800C	126	HP488DWAE	86	HS009GT201	14	KP001GZ01	15
FS2700	98	GD0801C	126	HR001GM202	12	HS009GZ	14	KP0800	140
FS4000	97	GD0810C	126	HR003GM201	12	HS011GT201	14	KP0800 + 824892-1	160
FS4300	97	<b>H</b>		HR003GZ01	12				
FS4300X2	97	HB350	102	HR004GM201	12				
FS6300R	98	HG5030K	150	HR004GZ01	12				

KP0810	140	M9503R	164	SK312GDZ	151	UB101DZ	71	UR3501	156
KP0810C	140	M9800X2	166	SK40GD	151	UB1103	145	UR3502	156
KP312S	141	MEU029J	160	SK700D	151	UC003GM101	19	UT1200	97
KT001GZ	18	MLS100N	134	SK700GD	151	UC003GZ	19	UT1305	97
<b>L</b>		MLT100N	134	SKR200Z	152	UC006GZ	20	UT1400	96
LB1200F	138	MP001GZ	18	SP001GZ03	13	UC011GT101	20	UT1401	96
LC1230N	115	MP100DZ	80	SP6000J	136	UC011GZ	20	UT1600	96
LD030P	152	MR001G	22	ST113DSAJ	70	UC015GT101	20	UT2204	97
LD050P	152	MR004G	23	<b>T</b>		UC015GZ	20	UV3200	155
LD080PI	152	MR006G	23	TD001GM201	9	UC3041A	155	UV3600	155
LF1000	133	MR007G	23	TD001GZ02	9	UC3051AX1	155	UX01GZ01	19
LH1040	133	MR052	81	TD0101F	94	UC3541A	155	<b>V</b>	
LH1201FL	133	<b>N</b>		TD022DSE	86	UC3551AX1	155	VC001GLZ	17
LM001CZ	33	N5900B	135	TD110DSAE	67	UC4041A	155	VC003GLZ	17
LS002GZ01	15	<b>P</b>		TD110DSME	67	UC4051AX1	155	VC004GLZ01	17
LS003GZ01	15	PB002GZ	15	TD110DZ	67	UD2500	156	VC005GLZ	17
LS004GZ01	15	PC5000C	125	TD111DSAE	67	UH004GM201	21	VC008GZ	17
LS0714N	132	PC5010C	125	TD111DZ	67	UH004GZ	21	VC009GZ01	18
LS0815FLN	132	PF0300	158	TD112DMZ	66	UH005GM201	21	VC2000L	145
LS1018LN	132	PF0410	158	TL064DSAJ	67	UH005GZ	21	VC2012L	145
LS1018LN + DEAWST07	161	PF0800	158	TL065DSAJ	67	UH006GM201	21	VC2512L	145
LS1019L	132	PF1010	158	TM3010C	126	UH006GZ	21	VC3011L	145
LS1040N	133	PJ7000J	141	TM3010CX5J	126	UH007GM201	21	VC3012L	145
LS1219L	132	PO6000C	122	TM30DWYE	69	UH007GZ	21	VC3012M	145
LS1219L + DEAWST07	161	PT001GD101	16	TM30DZ	69	UH008GZ	21	VC4210L	145
LW1401	115	PT001GZ	16	TW001GM201	9	UH013GZ	22	VC4210M	145
<b>M</b>		PV001GM101	12	TW001GZ	9	UH014GM101	22	<b>W</b>	
M1901	167	PV001GZ	12	TW004GD201	10	UH014GZ	22	WR100DSA	67
M1902	167	PV301DZ	68	TW004GZ	10	UH4861	156	WR100DSM	67
M2401	165	PV7000C	125	TW007GM201	10	UH5261	157	WR100DZ	67
M2402	165	<b>R</b>		TW007GZ	10	UH5570	157		
M3601	166	RP0900	142	TW0200	98	UH6570	157		
M3602	167	RP1111CJ	142	TW0350	98	UH6580	157		
M3702	166	RP1803FXJ	142	TW060DSAE	66	UH7580	157		
M4301	165	RP2303FCXJ	142	TW060DZ	66	UM600DSAP	71		
M4500K	166	RS001GM101	14	TW1000	98	UM600DWAEX	71		
M4501K	166	RS001GZ	14	TW140DSMJ	66	UM600DZX	71		
M5802	165	RS002GT101	14	TW140DZ	66	UN460WDWA	87		
M6002	163	RS002GZ	14	TW141DSAE	66	UN460WDZ	87		
M6600	163	RT0702C	141	TW141DZ	66	UR002GZ01	18		
M8103	163	RT0702CX2J	141	TW161DSAE	66	UR006GM101	19		
M8103KX2	163	<b>S</b>		TW161DZ	66	UR006GZ02	19		
M8700	163	SA7000C	122	<b>U</b>		UR008GZ01	19		
M8701Z	163	SC103DZ	68	UA003GM101	20	UR012GZ02	8		
M9001	164	SG1251J	114	UA003GZ	20	UR100DSAEX	71		
M9203	165	SG150	114	UA004GM101	20	UR100DSAP	71		
M9204	164	SG150 + VC4210L	161	UA004GZ	20	UR100DWAE	71		
M9400	164	SG181	114	UB001CZ	33	UR100DZ	71		
M9502R	164	SK105DZ	151	UB001GM101	22	UR100DZX	71		
		SK106DZ	151	UB001GZ	22	UR101CZ	33		
				UB100DZ	71	UR3000	156		



**XGT**

# 40V Li-ion max

**High Power**

**Durability**

**Digital  
Communication**

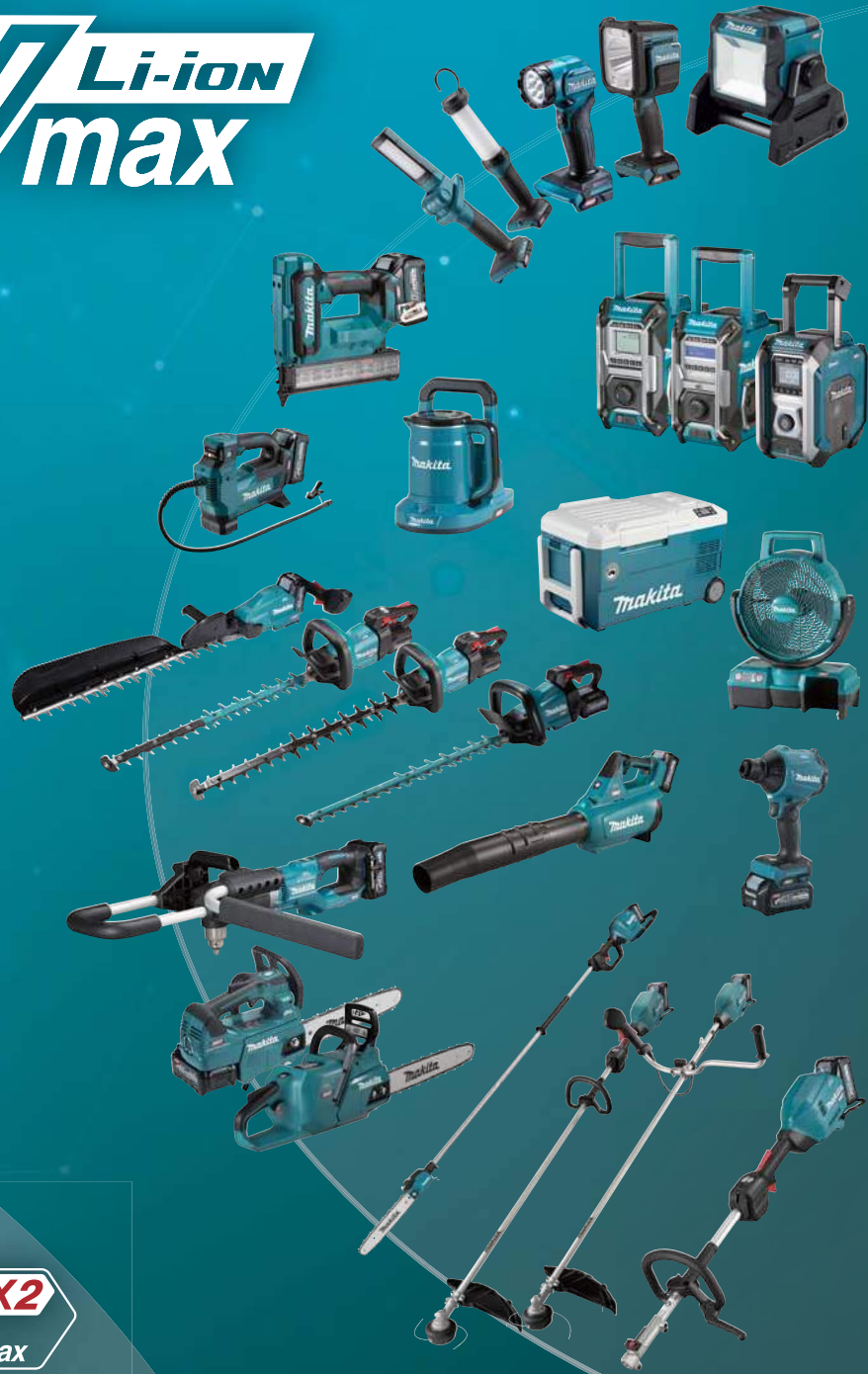

**XGT**

# 40V Li-ion max

**XGT X2**  
80V max



## Battery

**BL4020**  
2.0Ah

**BL4025**  
2.5Ah





**Charger**

**BL4040**  
4.0Ah

**BL4050F**  
5.0Ah

**BL4080F**  
8.0Ah

**DC40RA**

**DC40RB**

**DC40RC**

**ADP10**



Adapter for  
LXT Battery



Aku SDS MAX kombinované kladivo HR006G

Li-ion



Energia príklepu	EPTA-Procedure 05/2009: 20 J
Max. vrtací výkon	Betón s vrtákom 52 mm
Počet úderov / min	1.100 – 2.250
Voľnobežné otáčky	150 – 310
Hmotnosť	13,3 – 13,9 kg

XGT X2 80Vmax

XGT BL MOTOR AFT AWS AVT SOFT NOLOAD XPT



HR006GZ 1 195,99 €

Aku SDS MAX búracie kladivo HM002G

NOVINKA

Li-ion



Energia príklepu	EPTA-Procedure 05/2009: 20,9 J
Počet úderov / min	950 – 1,900
Uroveň akustického tlaku	92 dB(A)
Uroveň akustického výkonu	103 dB(A)
Vibrácie	8,0 m/s <sup>2</sup>
Hmotnosť	12,0 – 13,3 kg

XGT X2 80Vmax

XGT BL MOTOR AFT AWS AVT SOFT NOLOAD XPT



HM002GZ03 852,99 €

Aku rozbrusovačka CE001G 355 mm

NOVINKA

Li-ion



Priemer kotúča	355 mm (14")
Max. rezný výkon	127 mm (5")
Voľnobežné otáčky / min <sup>-1</sup>	5.300
Rozmery	786 x 272 x 433 mm
Hmotnosť	12,3 – 12,9 kg

XGT X2 80Vmax

WG WET GUARD AFT XGT XPT BL MOTOR



CE001GZ Cena na vyžiadanie

Aku krovinořez UR012G

Li-ion



Rezná šírka	Kovový žací nůž 305 mm Žacia hlava 480 mm TCT Pilový kotúč 255 mm Plastový nůž 305 mm
Voľnobežné otáčky / min <sup>-1</sup>	Max/priemer/min 0 – 6.800 / 0 – 5.000 / 0 – 3.500
Uchytenie na vretene	M10 x 1,25 LH
Rozmery	1.790 x 680 x 590 mm
Hmotnosť	8,0 – 9,3 kg

XGT X2 80Vmax

WG WET GUARD XGT AFT ADT BL MOTOR



UR012GZ02 894,99 €

Aku skrutkovač DF001G

Li-ion



Max. vrtací výkon	Železo: 20 mm Drevo: 76 mm
Rozsah skľučovadla	1,5 – 13 mm
Voľnobežné otáčky / min <sup>-1</sup>	Max / Min: 0 – 2.600 / 0 – 650
Max. uťahovací moment	Tvrдый / mäkký spoj: 115 / 60 N·m
Max. povoľovací moment	125 N·m
Hmotnosť	2,6 – 3 kg

40V Li-Ion XGT AFT XPT BL MOTOR



DF001GM201 779,99 €

DF001GZ01 311,99 €



### Aku skrutkovač

DF002G

Li-ion



Max. vrtací výkon	Železo / drevo: 13 / 38 mm
Rozsah skľučovadla	1,5 – 13 mm
Voľnobežné otáčky / min <sup>-1</sup>	Max / Min: 0 – 2.200 / 0 – 600
Max. ťahovací moment	Tvrдый / mäkký spoj: 64 / 30 Nm
Vibrácie	Vrtanie do železa: 2,5 m/s <sup>2</sup>
Úroveň akustického tlaku	78 dB(A)
Hmotnosť	1,9 – 2,8 kg



DF002GA201  
488,99 €

DF002GZ  
166,99 €

### Aku skrutkovač s príklepom

HP001G

Li-ion



Max. vrtací výkon	Železo: 20 mm Drevo: 76 mm Murivo: 20 mm
Rozsah skľučovadla	1,5 – 13 mm
Počet úderov za minútu	Max / Min: 0 – 39.000 / 0 – 9.750
Voľnobežné otáčky / min <sup>-1</sup>	Max / Min: 0 – 2.600 / 0 – 650
Max. ťahovací moment	Tvrдый / mäkký spoj: 115 / 60 N.m
Max. povoloovací moment	125 N.m
Rozmery	2,7 – 3 kg



HP001GM201  
789,99 €

HP001GZ01  
322,99 €

### Aku skrutkovač s príklepom

HP002G

Li-ion



Max. vrtací výkon	Železo / drevo / murivo: 13 / 38 / 13 mm
Rozsah skľučovadla	1,5 – 13 mm
Počet úderov za minútu	Max / Min: 0 – 33.000 / 0 – 9.000
Voľnobežné otáčky / min <sup>-1</sup>	Max / Min: 0 – 2.200 / 0 – 600
Max. ťahovací moment	Tvrдый / mäkký spoj: 64 / 30 Nm
Vibrácie	Vrtanie do železa: 2,5 m/s <sup>2</sup> Vrtanie s príklepom murivo: 9,0 m/s <sup>2</sup>
Úroveň akustického tlaku	87 dB(A)
Úroveň akustického výkonu	98 dB(A)
Hmotnosť	2,0 – 2,9 kg



HP002GA201  
499,99 €

HP002GZ  
176,99 €

### Aku rázový skrutkovač

TD001G

Li-ion



Max. vrtací výkon	Skrutka so šesťhrannou hlavou: M4 – M8 Skrutka štandardná: M5 – M16 Skrutka vysokopevnostná: M5 – M14
Upínanie	1/4"
Voľnobežné otáčky min <sup>-1</sup>	Max / Hard / Med / Soft 0 – 3.700 / 3.200 / 2.100 / 1.100
Počet úderov za minútu	Max / Hard / Med / Soft 0 – 4.400 / 3.600 / 2.600 / 1.100
Max. ťahovací moment	220 N.m
Rozmery	120x86x250 mm
Hmotnosť	1,7 – 2,0 kg



TD001GM201  
789,99 €

TD001GZ02  
322,99 €

### Aku rázový ťahovač

TW001G

Li-ion



Max. ťahovací výkon	Skrutka štandardná: M12 – M36 Skrutka vysokopevnostná: M10 – M27
Upínanie	3/4"
Voľnobežné otáčky / min <sup>-1</sup>	Max/tvrдый / stredný / mäkký spoj: 0 – 1.800 / 0 – 1.400 / 0 – 1.150 / 0 – 950
Počet úderov za minútu	Max / tvrдый / stredný / mäkký spoj: 0 – 2.500 / 0 – 2.400 / 0 – 2.200 / 0 – 1.900
Max. ťahovací moment	1.630 N.m
Rozmery	217x94x303 mm
Hmotnosť	3,9 – 4,2 kg



TW001GZ  
405,99 €

TW001GM201  
894,99 €

## Aku rázový uťahovač

TW004G

Li-ion



Max. uťahovací výkon	Skrutka štandardná: M10 – M20 Skrutka vysokopevnosťná: M10 – M16
Upínanie	1/2"
Voľnobežné otáčky / min <sup>-1</sup>	Max / tvrdý / stredný / mäkký spoj: 0 – 3.200 / 2.600 / 1.800 / 1.000
Počet úderov za minútu	Max / tvrdý / stredný / mäkký spoj: 0 – 4.000 / 3.400 / 2.600 / 1.800
Max. uťahovací moment	350 Nm
Hmotnosť	1,9 – 2,2 kg

40V<sup>Li-ion</sup><sub>max</sub>

XGT BL MOTOR XPT

TW004GD201  
675,99 €TW004GZ  
279,99 €

## Aku rázový uťahovač

TW007G

NOVINKA

Li-ion



Max. uťahovací výkon	Skrutka štandardná: M10 – M24 Skrutka vysokopevnosťná: M10 – M16
Upínanie	1/2"
Voľnobežné otáčky / min <sup>-1</sup>	Max / tvrdý / stredný / mäkký spoj 0 – 2.300 / 1.900 / 1.200 / 600
Počet úderov za minútu	0 – 2.900 / 2.700 / 1.900 / 1.200
Max. uťahovací moment	760 Nm
Úroveň akustického tlaku	97 dB(A)
Úroveň akustického výkonu	108 dB(A)
Hmotnosť	2,7 – 3,3 kg

40V<sup>Li-ion</sup><sub>max</sub>

XGT BL MOTOR XPT

TW007GM201  
829,99 €TW007GZ  
363,99 €

## Aku uhlová vrtáčka

DA001G

NOVINKA

Li-ion



Max. vrtací výkon	železo: 13 mm drevo (vrták 118 mm / korunka 159 mm)
Voľnobežné otáčky	Max / Min: 0 – 1.500 / 0 – 400
Max. uťahovací moment	Max / Min: 136 Nm / 55 Nm
Vibrácie	2,5 m/s <sup>2</sup>
Úroveň akustického tlaku	84 dB(A)
Úroveň akustického výkonu	95 dB(A)
Hmotnosť	5,3 – 6,2 kg

40V<sup>Li-ion</sup><sub>max</sub>

XGT BL MOTOR XPT ADT

DA001GZ  
623,99 €

## Aku ofukovač

AS001G

NOVINKA

Li-ion



Max. výkon	4/3/2/1: 2,8/2,3/1,7/1,1 N
Max. prietok vzduchu	4/3/2/1: 1,1/1,0/0,8/0,6 m <sup>3</sup> /min
Vibrácie	2,5 m/s <sup>2</sup>
Úroveň akustického tlaku	79 dB(A)
Hmotnosť	1,5 – 2,3 kg

40V<sup>Li-ion</sup><sub>max</sub>

XGT BL MOTOR

AS001GA101  
343,99 €AS001GZ  
166,99 €

## Aku uhlová brúska

GA005G

Li-ion



Priemer kotúča	125 mm
Voľnobežné otáčky / min <sup>-1</sup>	8.500
Rozmery	410x140x168 mm
Hmotnosť	2,9 – 3,6 kg

40V<sup>Li-ion</sup><sub>max</sub> XGT BL MOTOR ADT XPT (BRAKE)GA005GD201  
644,99 €GA005GM201  
748,99 €GA005GZ01  
279,99 €

**Aku uhlová brúska**

GA023G

**Li-ion**



Priemer kotúča 125 mm  
 Voľnobežné otáčky / min<sup>-1</sup> 3 000 – 8 500  
 Hmotnosť 3 – 4,4 kg

**40V<sup>Li-ion</sup> max**  
**XGT MOTOR AFT**  
**AWS XPT (BRAKE)**



**GA023GM201**  
 779,99 €

**GA023GZ**  
 279,99 €

**Aku uhlová brúska**

GA029G

**Li-ion**



Priemer kotúča 125 mm  
 Voľnobežné otáčky / min<sup>-1</sup> 3 000 – 8 500  
 Hmotnosť 3 – 4,5 kg

**40V<sup>Li-ion</sup> max**  
**XGT MOTOR AFT**  
**AWS XPT (BRAKE)**



**GA029GM201**  
 789,99 €

**GA029GZ**  
 291,99 €

**Aku uhlová brúska**

GA035GZ

**Li-ion**



Priemer kotúča 150 mm  
 Voľnobežné otáčky / min<sup>-1</sup> 8.500  
 Rozmery 410×171×168 mm  
 Hmotnosť 3,0 – 3,7 kg

**40V<sup>Li-ion</sup> max**  
**XGT MOTOR AFT**  
**XPT (BRAKE)**



**GA035GZ**  
 259,99 €

**Aku uhlová brúska**

GA036GZ

**Li-ion**



Priemer kotúča 150 mm  
 Voľnobežné otáčky / min<sup>-1</sup> 8.500  
 Rozmery 410×171×168 mm  
 Hmotnosť 3,0 – 3,7 kg

**40V<sup>Li-ion</sup> max**  
**XGT MOTOR AFT**  
**XPT (BRAKE)**



**GA036GZ**  
 269,99 €

**Aku uhlová brúska**

GA038GZ

**Li-ion**



Priemer kotúča 230 mm  
 Voľnobežné otáčky / min<sup>-1</sup> 6.600  
 Rozmery 499×250×180 mm  
 Hmotnosť 4,6 – 5,2 kg

**40V<sup>Li-ion</sup> max**  
**XGT MOTOR AFT**  
**AWS XPT (BRAKE)**



**GA038GM201**  
 759,99 €

**GA038GT201**  
 831,99 €

**GA038GZ**  
 259,99 €



## Aku leštička

PV001G 180 mm

NOVINKA

Li-ion



Priemer brúsneho kotúča	Pad: 180 mm
Voľnobežné otáčky	0 – 2.200
Rozmery	547 × 198 × 196 mm
Hmotnosť	3,1 – 3,8 kg



**PV001GM101**  
Cena na vyžiadanie

**PV001GZ**  
Cena na vyžiadanie

## Aku SDS Plus kombinované kladivo

HR001G

Li-ion



Energia príklepu	EPTA-Procedure 05/2009: 2,8 J
Max. vrtací výkon	Betón (s vrtákom): 28 mm Betón (s vrtacou korunkou): 65 mm
Počet úderov / min	0 – 5.000
Voľnobežné otáčky	0 – 980
Rozmery	358×121×232 mm
Hmotnosť	3,9 – 4,6kg



**HR001GM202**  
977,99 €

## Aku SDS Plus kombinované kladivo

HR003G / HR004G

Li-ion



Energia príklepu	EPTA-Procedure 05/2009: 2,8 J
Max. vrtací výkon	Betón (s vrtákom): 28 mm Betón (s vrtacou korunkou): 65 mm
Rozsah skľučovadla	1,5 – 13 mm
Počet úderov / min	0 – 5.000
Voľnobežné otáčky	0 – 980
Hmotnosť	HR003G: 3,9 – 4,6 kg HR004G: 4,0 – 4,5 kg



**HR003GM201**  
894,99 €

**HR003GZ01**  
426,99 €

**HR004GM201**  
935,99 €

**HR004GZ01**  
467,99 €

## Aku SDS MAX kombinované kladivo

HR005GZ

Li-ion



Energia príklepu	EPTA-Procedure 05/2009: 8 J
Max. vrtací výkon	Betón s vrtákom 40 mm
Počet úderov / min	1.450 – 2.900
Voľnobežné otáčky	250 – 500
Hmotnosť	7,5 – 8,0 kg



**HR005GM202**  
1 362,99 €

**HR005GZ01**  
873,99 €

## Aku SDS Plus kombinované kladivo

HR007G

NOVINKA

Li-ion



Energia príklepu	EPTA-Procedure 05/2009: 3,0 J
Max. Vrtací výkon	betón / železo / drevo / korunka / dia korunky na sucho 28 / 13 / 32 / 54 / 65 mm
Počet úderov / min	0 – 5.000
Voľnobežné otáčky	0 – 980
Úroveň akustického tlaku	94 dB(A)
Úroveň akustického výkonu	105 dB(A)
Hmotnosť	3,8 – 4,8 kg



**HR007GM201**  
873,99 €

**HR007GZ**  
359,99 €

Aku SDS-MAX búracie kladivo

HM001GZ

Li-ion



Energia príklepu	EPTA-Procedure 05/2009: 9,4 J
Počet úderov / min	0 – 2.600
Úroveň akustického tlaku	89 dB(A)
Úroveň akustického výkonu	100 dB(A)
Hmotnosť	6,3 – 6,8 kg

40V<sup>Li-ion</sup> max

XGT BL MOTOR

AWS AVT SOFT NO LOAD XPT



HM001GM201  
1 039,99 €

HM001GZ02  
551,99 €

Aku chvostová píla

JR001G

Li-ion



Dĺžka kmitu	32 mm
Kmity / min	Max/min: 0 – 3.000 / 0 – 2.300
Max. rezný výkon	Rúra: 130 mm
	Drevo: 255 mm
Rozmery	472×88×239 mm
Hmotnosť	4,2 – 4,5 kg

40V<sup>Li-ion</sup> max

XGT BL MOTOR XPT



JR001GM201  
799,99 €

JR001GZ  
301,99 €

Aku chvostová píla

JR002G

NOVINKA

Li-ion



Dĺžka kmitu	32 mm
Kmity / min	0 – 3.000
Max. rezný výkon	Rúra: 130 mm
	Drevo: 255 mm
Rozmery	436 × 97 × 250 mm
Hmotnosť	4,6 – 5,2 kg

40V<sup>Li-ion</sup> max

BL MOTOR XPT AVT



JR002GM201  
Cena na vyziadanie

JR002GZ  
Cena na vyziadanie

Aku ponorná píla

SP001G

NOVINKA

Li-ion



Priemer kotúča	165 mm
Max rezný výkon	90°: 56 mm
	45°: 40 mm
	48°: 38mm
Voľnobežné otáčky / min <sup>-1</sup>	2.500 – 4.900
Vibrácie	2,5 m/s <sup>2</sup>
Úroveň akustického tlaku	89 dB(A)
Úroveň akustického výkonu	100 dB(A)
Rozmery	347×221×271mm
Hmotnosť	4,4 – 5,0 kg

40V<sup>Li-ion</sup> max

AWS BL MOTOR XPT



SP001GZ03  
549,99 €

Aku kotúčová píla

HS004G

Li-ion



Priemer kotúča	190 mm
Vrtanie kotúča	30 mm
Max. rezný výkon	90°: 62,5 / 60 mm, 45°: 44,5 / 43 mm
Voľnobežné otáčky / min <sup>-1</sup>	6.000
Rozmery	337×210×290 mm
Hmotnosť	4,5 – 4,8 kg

Pripojenie na lištu bez adaptéru áno

40V<sup>Li-ion</sup> max

XGT BL MOTOR

ADT (BRAKE) XPT



HS004GM202  
1 039,99 €

HS004GZ01  
539,99 €

## Aku kotúčová píla

HS009G 235 mm

NOVINKA

Li-ion



Priemer kotúča	235 mm
Max. rezný výkon	0°: 85 mm
	45°: 61 mm
	60°: 44 mm
Voľnobežné otáčky / min <sup>-1</sup>	4.000
Rozmery	413 × 196 × 316 mm
Hmotnosť	5,1 - 5,7 kg



HS009GT201  
1 099,99 €

HS009GZ  
467,99 €

## Aku kotúčová píla

HS011G 270 mm

NOVINKA

Li-ion



Priemer kotúča	260 - 270 mm
Max. rezný výkon	0°: 97 - 101 mm
	45°: 61 mm
	45°: 68 - 71 mm
Voľnobežné otáčky / min <sup>-1</sup>	3.500
Rozmery	453 × 196 × 336 mm
Hmotnosť	5,5 - 6,1 kg



HS011GT201  
Cena na vyžiadanie

HS011GZ  
Cena na vyžiadanie

## Aku kotúčová píla so zadnou rukoväťou

RS001G

NOVINKA

Li-ion



Priemer kotúča	185 mm
Max rezný výkon	90°: 65 mm
	45°: 45 mm
	48°: 38mm
Voľnobežné otáčky / min <sup>-1</sup>	6,400
Vibrácie	2,5 m/s <sup>2</sup>
Úroveň akustického tlaku	92 dB(A)
Úroveň akustického výkonu	103 dB(A)
Rozmery	446×196×270 mm
Hmotnosť	5.0 - 5.6 kg
Pripojenie na lištu	nie



RS001GM101  
644,99 €

RS001GZ  
332,99 €

## Aku kotúčová píla so zadnou rukoväťou

RS002G

NOVINKA

Li-ion



Priemer kotúča	260 mm
Max rezný výkon	90°: 95 mm
	45°: 70 mm
	56°: 54.5 mm
Voľnobežné otáčky / min <sup>-1</sup>	4,000
Vibrácie	2.5m/s <sup>2</sup>
Úroveň akustického tlaku	96 dB(A)
Úroveň akustického výkonu	107dB(A)
Rozmery	489×193×309 mm
Hmotnosť	5.7 - 6.3 kg
Pripojenie na lištu	nie



RS002GT101  
863,99 €

RS002GZ  
519,99 €

## Aku píla na kov

CS002G 185 mm

NOVINKA

Li-ion



Priemer kotúča	185 mm
Max. rezný výkon	0°: 67 mm
Voľnobežné otáčky / min <sup>-1</sup>	3.500
Rozmery	350 × 232 × 270 mm
Hmotnosť	4,3 - 4,9 kg



CS002GZ  
Cena na vyžiadanie



## Aku pásová píla

PB002G 127 × 127 mm

**NOVINKA**

**Li-ion**



Max. rezný výkon	127 × 127 mm
Rýchlosť noža	0 – 3,2 m/min
Veľkosť noža	1,140 × 13 mm
Rozmery	510 × 218 × 314 mm
Hmotnosť	6,5 – 7,1 kg



**PB002GZ**  
**582,99 €**

## Aku hoblík

KP001G 82 mm

**NOVINKA**

**Li-ion**



Šírka záberu	82 mm
Hĺbka hobľovania	4 mm
Voľnobežné otáčky / min <sup>-1</sup>	15.000
Rozmery	379 × 156 × 166
Hmotnosť	3,8 – 4,4 kg



**KP001GM202**  
**929,99 €**

**KP001GZ01**  
**399,99 €**

## Aku pokosová píla

LS002G

**Li-ion**



Priemer kotúča	216 mm
Max. uhol pokosu	60° L / 60° R
Max. uhol úkosu	48° L / 48° R
Max. rezný výkon	90° Pokos: 70×312 mm
Voľnobežné otáčky	4.800
Rozmery	702×551×557 mm
Hmotnosť	16,4 – 17,0 kg



**LS002GZ01**  
**799,99 €**

## Aku pokosová píla

LS003G

**NOVINKA**

**Li-ion**



Priemer kotúča	305 mm
Max. uhol pokosu	60° L / 60° R
Max. uhol úkosu	48° L / 48° R
Max. rezný výkon	90° Pokos: 92×382 mm
	107×363 mm
	45° Pokos, L/P: 92×268 mm
	107×255 mm
Voľnobežné otáčky	3.600
Úroveň akustického tlaku	91 dB(A)
Úroveň akustického výkonu	100 dB(A)
Rozmery	898×690×725 mm
Hmotnosť	30,5 – 31,1 kg



**LS003GZ01**  
**1 199,99 €**

## Aku pokosová píla

LS004G

**NOVINKA**

**Li-ion**



Priemer kotúča	260 mm
Max. uhol pokosu	60° L / 60° R
Max. uhol úkosu	48° L / 48° R
Max. rezný výkon	90° Pokos: 68×310 mm
	91×279 mm
	45° Pokos, L/P: 68×218 mm
	91×197 mm
Voľnobežné otáčky	3.600
Úroveň akustického tlaku	91 dB(A)
Úroveň akustického výkonu	100 dB(A)
Rozmery	805×644×660 mm
Hmotnosť	26,6 – 27,2 kg



**LS004GZ01**  
**1 059,99 €**

## Aku klincovačka

FN001

Li-ion



Dĺžka klincov	15 – 40 mm 18 Ga
Kapacita zásobníka	100
Hmotnosť	2.6 – 2.9 kg



**FN001GA201**  
873,99 €

**FN001GZ**  
499,99 €

## Aku klincovačka

PT001G 35 mm

NOVINKA

Li-ion



Dĺžka klincov	15, 18, 25, 30, 35 mm /23 Ga/
Kapacita zásobníka	120 mm
Rozmery	218 x 86 x 226 mm
Hmotnosť	2,4 – 3,0 kg



**PT001GD101**  
727,99 €

**PT001GZ**  
Cena na vyžiadanie

## Aku ventilátor

CF002G

NOVINKA

Li-ion



Max. rýchlosť vzduchu	120 m/min
Max. prietok vzduchu	Max / Priemer / Min: 240 / 170 / 120
Priemer ventilátora	330 mm
Hmotnosť	3,8 – 5,1 kg



**CF002GZ**  
219,99 €

## Aku vysávač

CL001G

NOVINKA

Li-ion



Objem zbernej nádoby	730 mL
Pracovný čas (min.)	BL4040: 1 / 2 / 3 / 4: 128 / 64 / 40 / 25
Max. prúdenie vzduchu	1,2 m³/min
Rozmery	1.066x113x152 mm
Hmotnosť	1,7 – 2,3 kg



**CL001GZ**  
176,99 €

## Aku vysávač

CL002G

NOVINKA

Li-ion



Objem zbernej nádoby	Zberné vrecko: 500 ml Papierový sáčok: 330 ml
Pracovný čas (min.)	BL4025 1 / 2 / 3 / 4 80 / 40 / 25 / 16 min
Rozmery	505 x 114 x 152 mm
Hmotnosť	1,8 – 3,0 kg



**CL002GZ01**  
176,99 €

**Aku vysávač**

**VC001G** mokré & suché vysávanie **NOVINKA**

**Li-ion**



Objem zbernej nádoby	Prach: 8 L
	Voda: 6 L
Pracovný čas (min.)	BL4050F x2: 220 min
Max. prietok vzduchu:	3,2 m <sup>3</sup> /min
Rozmery	366 × 334 × 425 mm
Hmotnosť	8,1 – 10,0 kg



**VC001GLZ**  
529,99 €

**Aku vysávač**

**VC003G** mokré & suché vysávanie **NOVINKA**

**Li-ion**



Objem zbernej nádoby	Prach: 15 L
	Voda: 12 L
Pracovný čas (min.)	BL4050F x2: 220 min
Max. prietok vzduchu:	3,2 m <sup>3</sup> /min
Rozmery	366 × 334 × 475 mm
Hmotnosť	8,3 – 10,2 kg



**VC003GLZ**  
549,99 €

**Aku vysávač**

**VC004G** suché vysávanie **NOVINKA**

**Li-ion**



Objem zbernej nádoby	Prach: 15 L
Pracovný čas (min.)	BL4050F x2: 220 min
Max. prietok vzduchu:	1,8 m <sup>3</sup> /min
Rozmery	366 × 334 × 475 mm
Hmotnosť	8,5 – 10,4 kg



**VC004GLZ01**  
699,99 €

**Aku vysávač**

**VC005G** suché vysávanie **NOVINKA**

**Li-ion**



Objem zbernej nádoby	Prach: 8 L
Pracovný čas (min.)	BL4050F x2: 220 min
Max. prietok vzduchu:	2,8 m <sup>3</sup> /min
Rozmery	366 × 334 × 397 mm
Hmotnosť	7,6 – 9,5 kg



**VC005GLZ**  
569,99 €

**Aku chrbtový vysávač**

**VC008G** **NOVINKA**

**Li-ion**



Objem zbernej nádoby	Vrečko na prach: 1,5 L
Max. prietok vzduchu:	2,4 m <sup>3</sup> /min
Rozmery	233 × 151 × 376 mm
Hmotnosť	4,3 – 4,7 kg



**VC008GZ**  
Cena na vyziadanie



## Aku chrbtový vysávač

VC009G

NOVINKA

Li-ion



40V<sup>Li-ion</sup>  
max  
AWS BL  
MOTOR



Objem zbernej nádoby	Vrečko na prach: 1,5 L
Max. prietok vzduchu:	1.9 m <sup>3</sup> /min
Rozmery	233 x 151 x 376 mm
Hmotnosť	4,3 - 4,7 kg

VC009GZ01  
Cena na vyžiadanie

## Aku rýchlovarná kanvica

KT001G

NOVINKA

Li-ion



40V<sup>Li-ion</sup>  
max  
XGT

Približný čas zohriatia	8 min (0,8L vody z 23 °C)
Water tank capacity	0,8 L
Dimensions (LxWxH)	233x322x307 mm
Net weight	2,8 - 5,9 kg

KT001GZ  
289,99 €

## Aku chladnička / ohrievač

CW001G

NOVINKA

Li-ion



40V<sup>Li-ion</sup>  
max  
LXT XGT

Objem	20 L
Chladiaci systém	Kompresor
Nastavenie chladenia	-18 / -15 / -10 / -5 / 0 / 5 / 10 °C
Zohrievaci systém	Ohrievač
Nastavenie zohrievania	30 / 35 / 40 / 45 / 50 / 55 / 60 °C
Pracovný čas	2xBL4050F -18°C / 5°C / 60 °C: 10h / 28h / 8,5h
Dĺžka kábla	El. kábel 2 m / kábel do zapalovača 2,5 m
Hmotnosť	13,5 - 16,1 kg

CW001GZ  
699,99 €

## Aku pumpa

MP001G

NOVINKA

Li-ion



40V<sup>Li-ion</sup>  
max  
XPT XGT  
EXTREME PROTECTION TECHNOLOGY



Max. tlak vzduchu	11,1 bar
Dĺžka hadice	65 cm
Rozmery	320x108x231 mm
Hmotnosť	2,9 - 3,5 kg

MP001GZ  
189,99 €

## Aku krovinorez

UR002G

NOVINKA

Li-ion



40V<sup>Li-ion</sup>  
max  
XGT BL WG  
MOTOR WET GUARD  
ADT AFT XPT  
EXTREME PROTECTION TECHNOLOGY



Rezná šírka	Kovový žací nôž: 230 mm
	Žacia hlava 350 mm
	Plastový nôž 255 mm
Voľnobežné otáčky / min <sup>-1</sup>	Max / Priemer / Min: 0 - 6.500 / 5.300 / 3.500
Uchytenie na vretene	M10x1,25 LH
Úroveň akustického tlaku	89,7 dB
Úroveň akustického výkonu	72,2 dB
Vibrácie	2,5 m/s <sup>2</sup>
Hmotnosť	4,6 - 5,2 kg

UR002GZ01  
415,99 €

Aku krovinořez

UR006G

NOVINKA

Li-ion



Rezná šířka	Kovový žací nůž: 255 mm Žací hlava 430 mm Plastový nůž 305 mm
Volnobežné otáčky / min <sup>-1</sup>	
Kovový žací nůž (3/2/1)	0 – 7,000 / 0 – 5,500 / 0 – 4,600
Žací hlava (3/2/1)	0 – 5,500 / 0 – 5,000 / 0 – 4,600
Plastový nůž (305 mm) (3/2/1)	0 – 7,000 / 0 – 5,500 / 0 – 4,600
Uchytenie na vretene	M10x1,25 LH
Hmotnosť	5,6 – 6,2 kg

UR006GM101  
779,99 €

UR006GZ02  
467,99 €

Aku krovinořez

UR008G

NOVINKA

Li-ion



Rezná šířka	Žací hlava 430 mm Plastový nůž 305 mm
Volnobežné otáčky / min <sup>-1</sup>	
Kovový žací nůž (3/2/1)	0 – 7,000 / 0 – 5,500 / 0 – 4,600
Žací hlava (3/2/1)	0 – 5,500 / 0 – 5,000 / 0 – 4,600
Plastový nůž (305 mm) (3/2/1)	0 – 7,000 / 0 – 5,500 / 0 – 4,600
Uchytenie na vretene	M10x1,25 LH
Hmotnosť	5,0 – 5,6 kg

UR008GZ01  
415,99 €

Aku krovinořez

UX01G

NOVINKA

Li-ion



Volnobežné otáčky	Max: 0 – 9.700 Stredné: 0 – 8.200 Min: 0 – 5.700
Rozmery	1.027x320x209 mm
Hmotnosť	4,1 – 4,7 kg

UX01GZ01  
384,99 €



Aku jednoručná píla

UC003G

NOVINKA

Li-ion



Dĺžka lišty	300 mm
Delenie reťaze	3/8"
Šírka drážky	1,1 mm
Rýchlosť reťaze	0 – 24,8 m/s
Nádžň na olej	200 mL
Úroveň akustického výkonu	100 dB(A)
Hmotnosť	3,8 – 4,7 kg

UC003GM101  
686,99 €

UC003GZ  
384,99 €

## Aku jednoručná píla /karvingová lišta/ UC006G

NOVINKA

Li-ion



Dĺžka lišty	250 mm
Delenie reťaze	1/4"
Šírka drážky	1,3 mm
Rýchlosť reťaze	0 – 24,8 m/s
Nádrž na olej	200 mL
Úroveň akustického výkonu	100 dB(A)
Hmotnosť	3,8 – 4,7 kg



UC006GZ  
447,99 €

## Aku reťazová píla UC011G

NOVINKA

Li-ion



Dĺžka lišty	350 mm
Delenie reťaze	3/8"
Šírka drážky	1,1 mm
Rýchlosť reťaze	0 – 24,7 m/s (0 – 1.482 m/min)
Nádrž na olej	230 mL
Rozmery	446 × 233 × 274 mm
Hmotnosť	6,0 – 6,5 kg



UC011GT101  
899,99 €

UC011GZ  
529,99 €

## Aku reťazová píla UC015G

NOVINKA

Li-ion



Dĺžka lišty	350 mm
Delenie reťaze	3/8"
Šírka drážky	1,1 mm
Rýchlosť reťaze	0 – 24,7 m/s (0 – 1.482 m/min)
Nádrž na olej	230 mL
Rozmery	446 × 233 × 274 mm
Hmotnosť	6,0 – 6,5 kg



UC015GT101  
899,99 €

UC015GZ  
529,99 €

## Aku vyvetvovacia píla UA003G

NOVINKA

Li-ion



Dĺžka lišty	300 mm
Delenie reťaze	3/8"
Šírka drážky	1,1 – 1,3 mm
Rýchlosť reťaze	0 – 20 m/s (0 – 1.200 m/min)
Nádrž na olej	160 mL
Rozmery	2 228 × 157 × 189 mm
Hmotnosť	6,0 – 7,3 kg



UA003GM101  
863,99 €

UA003GZ  
571,99 €

## Aku vyvetvovacia píla (teleskopická) UA004G

NOVINKA

Li-ion



Dĺžka lišty	300 mm
Delenie reťaze	3/8"
Šírka drážky	1,1 – 1,3 mm
Rýchlosť reťaze	0 – 20 m/s (0 – 1.200 m/min)
Nádrž na olej	160 mL
Rozmery	2 515 – 3 747 × 157 × 191 mm
Hmotnosť	7,6 – 8,9 kg



UA004GM101  
999,99 €

UA004GZ  
707,99 €



**Aku plotostrih**

**UH004G**

**NOVINKA**

**Li-ion**



Dĺžka noža	600 mm
Max. strižný výkon	23,5 mm
Počet strihov / min	Max / Priemer / Min 5.000 / 3.600 / 2.000
Úroveň akustického tlaku	85 dB(A)
Úroveň akustického výkonu	96 dB(A)
Hmotnosť	4,3 – 4,9 kg



**UH004GM201**  
894,99 €

**UH004GZ**  
405,99 €

**Aku plotostrih**

**UH005G**

**NOVINKA**

**Li-ion**



Dĺžka noža	750 mm
Max. strižný výkon	23,5 mm
Počet strihov / min	Max / Priemer / Min 5.000 / 3.600 / 2.000
Úroveň akustického tlaku	86 dB(A)
Úroveň akustického výkonu	97 dB(A)
Hmotnosť	4,5 – 5,1 kg



**UH005GM201**  
935,99 €

**UH005GZ**  
436,99 €

**Aku plotostrih**

**UH006G**

**NOVINKA**

**Li-ion**



Dĺžka noža	600 mm
Max. strižný výkon	25,0 mm
Počet strihov / min	Max / Priemer / Min 4.000 / 3.000 / 2.000
Úroveň akustického tlaku	81 dB(A)
Úroveň akustického výkonu	92 dB(A)
Hmotnosť	4,4 - 5,0 kg



**UH006GM201**  
909,99 €

**UH006GZ**  
419,99 €

**Aku plotostrih**

**UH007G**

**NOVINKA**

**Li-ion**



Dĺžka noža	750 mm
Max. strižný výkon	25,0 mm
Počet strihov / min	Max / Priemer / Min 4.000 / 3.000 / 2.000
Úroveň akustického tlaku	81 dB(A)
Úroveň akustického výkonu	92 dB(A)
Hmotnosť	4,6 – 5,2 kg



**UH007GM201**  
949,99 €

**UH007GZ**  
449,99 €

**Aku plotostrih**

**UH008G**

**NOVINKA**

**Li-ion**



Dĺžka noža	600 mm
Max. strižný výkon	21,5 mm
Počet strihov / min	Max / Priemer / Min 5.000 / 3.600 / 2.000
Úroveň akustického tlaku	82 dB(A)
Úroveň akustického výkonu	93 dB(A)
Hmotnosť	4,3 – 4,9 kg



**UH008GZ**  
363,99 €

## Aku plotostrih

UH013G 600 mm

NOVINKA

Li-ion



Dĺžka noža	600 mm
Max. strižný výkon	18 mm
Počet strihov / min	Max / Priemer / Min 5.000 / 3.600 / 2.000
Hmotnosť	3,9 – 4,5 kg



UH013GZ  
529,99 €

## Aku plotostrih

UH014G 750 mm

NOVINKA

Li-ion



Dĺžka noža	750 mm
Max. strižný výkon	18 mm
Počet strihov / min	Max / Priemer / Min 5.000 / 3.600 / 2.000
Hmotnosť	4,0 – 4,7 kg



UH014GM101  
842,99 €

UH014GZ  
544,99 €

## Aku fukár

UB001G

NOVINKA

Li-ion



Max. prietok vzduchu	0 – 13,5 m <sup>3</sup> /min turbo mód 16,0 m <sup>3</sup> /min
Max. rýchlosť vzduchu	53 m/s turbo mód 64 m/s
Voľnobežné otáčky / min <sup>-1</sup>	0 – 20.000 turbo mód 23.000
Uroveň akustického tlaku	83,7 dB(A)
Uroveň akustického výkonu	94,1 dB(A)
Vibrácie	2,5 m/s <sup>2</sup>
Rozmery	917 – 1.017×167×297 mm
Hmotnosť	3,1 – 3,9 kg



UB001GM101  
603,99 €

UB001GZ  
291,99 €

## Aku pôdny vrták

DG001G

NOVINKA

Li-ion



Max. výkon:	Piesočnatá zem: 200 mm Hlinitá zem: 150 mm
Voľnobežné otáčky:	Max/min: 0 – 1.500 / 0 – 400
Max. uťahovací moment:	Max 136 Nm / min 48 Nm
Uroveň akustického tlaku	84 dB(A)
Uroveň akustického výkonu	95 dB(A)
Hmotnosť:	7,2 – 8,1 kg



DG001GM105  
999,99 €

DG001GZ05  
696,99 €

## Aku rádio

MR001G

NOVINKA

Li-ion



Frekvencia	FM / AM: 87,5 - 108 MHz / 522 - 1.710 kHz
Veľkosť reproduktorov	89 mm x2
Max. výkon	40Vmax: 5 W x2
Bluetooth	nie
Rozmery	280×171×434 mm
Hmotnosť	4,6 – 5,4 kg
USB nabitie	áno
USB prehrávanie	nie
Dodávané s AC adaptérom	áno



MR001G  
176,99 €



Frekvencia	FM: 87,5 – 108 MHz DAB/DAB+: 174.928 – 239.200 MHz
Veľkosť reproduktorov	89 mm x2
Max. výkon	40 Vmax: 4,9 W x2
Bluetooth	5.0
Rozmery	280×171×434 mm
Hmotnosť	4,6 – 5,4 kg
USB nabíjanie	áno
USB prehrávanie	nie
Dodávané s AC adaptérom	nie



MR004G  
249,99 €



Frekvencia	FM / AM: 87,5 – 108 MHz / 522 – 1.710 kHz
Veľkosť reproduktorov	Bočné: Ø63,5 mm x2 / Spodný: Ø101,6 mm
Max. výkon	40Vmax: 5 W x2 + 25 W / 18V: 5 W x2 + 25 W / 14.4V: 3 W x2 + 15 W / 12Vmax: 2 W x2 + 10 W
Bluetooth	5.0
Rozmery	285×172×305 mm
Hmotnosť	5,6 – 6,4 kg
USB nabíjanie	áno
USB prehrávanie	nie
Dodávané s AC adaptérom	áno



MR006G  
269,99 €



Frekvencia	FM: 87,5 – 108 MHz DAB / DAB+: 174.928 – 239.200 MHz
Veľkosť reproduktorov	Bočné: Ø63,5 mm x2 / Spodný: Ø101,6 mm
Max. výkon	40Vmax: 5 W x2 + 25 W / 18V: 5 W x2 + 25 W / 14.4V: 3 W x2 + 15 W / 12Vmax: 2 W x2 + 10 W
Bluetooth	5.0
Rozmery	285×172×305 mm
Hmotnosť	5,5 – 6,3 kg
USB nabíjanie	áno
USB prehrávanie	nie
Dodávané s AC adaptérom	áno



MR007G  
299,99 €





# 18V X2 Lithium-ion

18V + 18V → 36V LXT

ROZŠÍRTE SI SVOJ LI-ION SORTIMENT



DLM382 / DLM432 / DLM460 / DLM462 /  
DLM463 / DLM465 / DLM530 / DLM532 /  
DLM533 / DLM534 / DLM536 / DLM537

DUC405 / DUC400 / DUC355 /  
DUC353 / DUC305 / DUC303 /  
DUC256 / DUC306 / DUC356 /  
DUC406

DHR263 / DHR264 /  
DHR280, DHR282+DX08 /  
DHR281, DHR283+DX09

DDA460

DGA701 / DGA901 /  
DGA700 / DGA900

DHW080

DVP181

DHR400N

DUB361 / DUB362 /  
DUB363

DLS714 / DLS110 / DLS111 /  
DLS112 / DLS211 / DLS212

DJR360

DCE090

DHS710 / DHS711 / DHS781  
/ DHS780 / DHS782 /  
DHS783 / DHS900 / DHS901

DUR364L / DUR368A /  
DUR368L / DUR369A /  
DUR369L / DUR369N

DR5780

DUP361 / DUP362

DWT310

DSP600 / DSP601

DUA250 / DUA251 /  
DUA300 / DUA301

DVC560

DLW140

Power Head  
DUX60

DDG460

DVC261 / DVC265 / DVC660 /  
DVC665

DVC865L / DVC866L / DVC867L /  
DVC155L / DVC156L / DVC157L

DVC860L / DVC861L / DVC150L /  
DVC151L

PDC1200

PDC01

BAP182

ROZŠÍRTE SI SVOJ AKU SORTIMENT



## Aku fúrik

DCU180Z

Li-ion



Max. pracovný čas (min)	s BL1860B: 120
Nosnosť	130 kg
Rýchlosť	Vpred, 1 / 2: 0 – 3,5 / 0 – 1,5 km/h
	Vzad: 0 – 1 km/h
Max. stúpanie	12°
Hmotnosť	39,3 – 44,8 kg

18V



**BL** **XPT** **LXT**  
MOTOR EXTREME PROTECTION TECHNOLOGY

DCU180Z  
1 045,99 €

DCU180Z + 199009-8  
1 199,99 €

DCU180Z + 199008-0  
1 199,99 €

## Aku uhlová brúska

DGA900 230 mm

Li-ion



Priemer kotúča	230 mm
Voľnobežné otáčky / min <sup>-1</sup>	6.000
Úroveň akustického tlaku	88 dB(A)
Úroveň akustického výkonu	99 dB(A)
Rozmery	499×250×158 mm
Hmotnosť	5,2 – 8,0 kg

18V



**BL** **ADT** **AFT** **(BRAKE)** **XPT**  
MOTOR LXT EXTREME PROTECTION TECHNOLOGY

DGA900PT2  
648,99 €

DGA900Z  
311,99 €

## Aku uhlová brúska

DGA901 230 mm

Li-ion



Priemer kotúča	230 mm
Voľnobežné otáčky / min <sup>-1</sup>	6.000
Úroveň akustického tlaku	88 dB(A)
Úroveň akustického výkonu	99 dB(A)
Rozmery	499×250×158 mm
Hmotnosť	5,2 – 8,0 kg

18V



**BL** **ADT** **AFT** **(BRAKE)** **XPT**  
MOTOR AWS LXT EXTREME PROTECTION TECHNOLOGY

DGA901T2U1  
757,99 €

DGA901ZUX1  
432,99 €

## Aku rozbrusovačka

DCE090

Li-ion



Priemer kotúča	230 mm
Vítanie kotúča	22,23 mm
Max. hrúbka kotúča	3,0 mm
Max. rezný výkon	88 mm
Voľnobežné otáčky	6 600
Vibration Level	Left / Right: 5,9 / 4,0 m/s <sup>2</sup>
Úroveň akustického tlaku	103 dB(A)
Úroveň akustického výkonu	114 dB(A)
Hmotnosť	5,6 – 6,3 kg

18V



**BL** **ADT** **AFT** **(BRAKE)** **XPT**  
MOTOR LXT EXTREME PROTECTION TECHNOLOGY

DCE090ZX1  
648,99 €

## Aku reťazová píla

DUC306 300 mm

Li-ion



Dĺžka lišty	300 mm
Delenie reťaze	3/8"
Šírka drážky	1,1 / 1,3 mm
Rýchlosť reťaze	0 – 20 m/s
Nádž na olej	200 mL
Úroveň akustického tlaku	89 dB(A)
Úroveň akustického výkonu	103 dB(A)
Rozmery	270 – 651×205×232 mm
Hmotnosť	4,6 – 5,1 kg

18V



**BL** **ADT** **AFT** **(BRAKE)** **XPT**  
MOTOR LXT EXTREME PROTECTION TECHNOLOGY

DUC306PT2B  
675,99 €

DUC306ZB  
346,99 €



## Aku reťazová píla

DUC353 350 mm

Li-ion



Dĺžka lišty	350 mm
Delenie reťaze	3/8"
Šírka drážky	1,1 / 1,3 mm
Rýchlosť reťaze	0 – 20 m/s (0 – 1.200 m/min) (0 – 3.940 FPM)
Nádrž na olej	200 mL
Úroveň akustického tlaku	87,7 dB(A)
Úroveň akustického výkonu	100,4 dB(A)
Rozmery	773×215×235 mm
Hmotnosť	4,6 – 5,5 kg

18V

**BL MOTOR** **XPT** **LXT**  
EXTREME PROTECTION TECHNOLOGY
**DUC353Z**  
**327,99 €**

## Aku reťazová píla

DUC355 350 mm

Li-ion



Dĺžka lišty	350 mm
Delenie reťaze	3/8"
Šírka drážky	1,1 / 1,3 mm
Rýchlosť reťaze	0 – 20 m/s (0 – 1.200 m/min) (0 – 3.940 FPM)
Nádrž na olej	200 mL
Úroveň akustického tlaku	87,7 dB(A)
Úroveň akustického výkonu	100,4 dB(A)
Rozmery	762×211×235 mm
Hmotnosť	4,7 – 5,4 kg

18V

**BL MOTOR** **XPT** **LXT**  
EXTREME PROTECTION TECHNOLOGY
**DUC355PT2**  
**603,99 €**
**DUC355Z**  
**327,99 €**

## Aku uhlová vrtáčka

DDA460 13 mm

Li-ion



Max. vrtací výkon	železo 13 mm, drevo (vrták 118 mm / korunka 159 mm)
Voľnobežné otáčky	Max: 0 – 1.400 min <sup>-1</sup> Min: 0 – 350 min <sup>-1</sup>
Max. ťahovací moment	Max: 136 Nm Min: 48 Nm
Vibrácie	vrtanie do železa 2,5 m/s <sup>2</sup>
Úroveň akustického tlaku	85 dB (A)
Úroveň akustického výkonu	96 dB (A)
Rozmery	538×128×223 mm
Hmotnosť	5,7 – 6,4 kg

18V

**LXT**  
**XPT ADT BL MOTOR**  
EXTREME PROTECTION TECHNOLOGY
**DDA460Z**  
**623,99 €**

## Aku SDS Max kladivo

DHR400 40 mm

Li-ion



Energia príklepu	EPTA-Procedure 05/2009: 8,0 J
Max. vrtací výkon	Betón (s vrtákom): 40 mm Betón (s vrtácou korunkou): 105 mm
Počet úderov / min	1.450 – 2.900
Voľnobežné otáčky	250 – 500
Rozmery	473×120×285 mm
Hmotnosť	7,3 kg

18V

**AVT** **LXT**  
**AWS BL MOTOR XPT**  
ANTI VIBRATION TECHNOLOGY
**DHR400ZKUN**  
**899,99 €**

## Aku SDS Plus kladivo

DHR282 28 mm

Li-ion



Energia príklepu	EPTA-Procedure 05/2009: 2,8 J
Max. vrtací výkon	Betón/železo/drevo: 28 / 13 / 32 mm
Počet úderov / min <sup>-1</sup>	0 – 5000
Voľnobežné otáčky	0 – 980
Vibrácie	Vrtanie s príklepom do betónu: 9,0 m/s <sup>2</sup> Vrtanie do železa: 2,5 m/s <sup>2</sup>
Úroveň akustického tlaku	93 dB (A)
Úroveň akustického výkonu	104 dB (A)
Rozmery	373×134×232 mm
Hmotnosť	3,9 – 5,0 kg

18V

**AVT** **AFT** **LXT**  
**AWS BL MOTOR XPT ADT SOFT NOLOAD**  
ANTI VIBRATION TECHNOLOGY
**DHR282TJU**  
**863,99 €**
**DHR282ZU**  
**499,99 €**



### Aku SDS Plus kladivo

DHR280 28 mm

Li-ion



18V



**AVT** ANTI VIBRATION TECHNOLOGY  
**ADT**  
**LXT**  
**BL** MOTOR  
**XPT** EXTREME PROTECTION TECHNOLOGY  
**SOFT** NO LOAD

Energia príklepu	EPTA-Procedure 05/2009: 2,8 J
Max. vrtací výkon	Betón/železo/drevo: 28 / 13 / 32 mm
Počet úderov / min <sup>-1</sup>	0 – 5000
Voľnobežné otáčky	0 – 980
Vibrácie	Vítanie s príklepom do betónu: 9,0 m/s <sup>2</sup> Vítanie do železa: 2,5 m/s <sup>2</sup>
Úroveň akustického tlaku	93 dB (A)
Úroveň akustického výkonu	104 dB (A)
Rozmery	373×134×232 mm
Hmotnosť	3,9 – 4,9 kg

**DHR280PT2J**  
727,99 €

**DHR280Z**  
378,99 €

### Aku SDS Plus kladivo

DHR263 26 mm

Li-ion



18V



**XPT** EXTREME PROTECTION TECHNOLOGY  
**LXT**

Energia príklepu	EPTA-Procedure 05/2009: 2,5 J
Max. vrtací výkon	Betón/železo/drevo: 26 / 13 / 32 mm
Počet úderov / min <sup>-1</sup>	0 – 5.000
Voľnobežné otáčky / min <sup>-1</sup>	0 – 1.250
Vibrácie	Vítanie s príklepom do betónu: 15,5 m/s <sup>2</sup> Vítanie do železa: 5,0 m/s <sup>2</sup>
Úroveň akustického tlaku	94 dB(A)
Úroveň akustického výkonu	105 dB(A)
Rozmery	374×116×232 mm
Hmotnosť	4,2 – 5,1 kg

**DHR263PT2J**  
727,99 €

**DHR263Z**  
291,99 €

### Aku pokosová píla

DLS211 305 mm

Li-ion

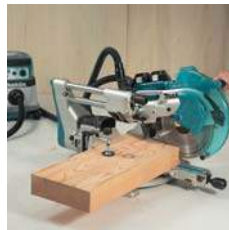

18V



**DXT** Deep and Exact Cutting Technology  
**LXT**  
**AWS** MOTOR  
**BL** MOTOR  
**ADT**

Priemer kotúča	305 mm
Max. uhol pokosu	60° L / 60° R
Max. uhol úkosu	48° L / 48° R
Max. rezný výkon (pokos / úkos)	90° 107×363 mm 90° 92×382 mm 45° L/R: 107×255 mm 45° L/R: 92×268 mm
Voľnobežné otáčky / min <sup>-1</sup>	4.400
Úroveň akustického tlaku	95 dB(A)
Úroveň akustického výkonu	103 dB(A)
Vibrácie	2,5 m/s <sup>2</sup>
Rozmery	898×690×725 mm
Hmotnosť	30,7 – 31,3 kg

**DLS211ZU**  
1 189,99 €

### Aku okružná píla

DHS900ZU

Li-ion



18V



**XPT** EXTREME PROTECTION TECHNOLOGY  
**LXT** (BRAKE)  
**AWS** MOTOR  
**BL** MOTOR  
**ADT**

Priemer kotúča	235 mm
Max rezný výkon	90°: 85 mm 45°: 61 mm 60°: 44 mm
Voľnobežné otáčky / min <sup>-1</sup>	4.500
Rozmery	413×196×316 mm
Hmotnosť	5,3 – 6,0 kg

Pripojenie na lištu bez adaptéru áno

**DHS900ZU**  
616,99 €

### Aku okružná píla

DHS783 / DHS782

Li-ion



18V



**XPT** EXTREME PROTECTION TECHNOLOGY  
**LXT** (BRAKE)  
**AWS** MOTOR  
**BL** MOTOR  
**ADT**

Priemer kotúča	190 / 185 mm
Max rezný výkon	90°: 62,5 / 60 mm 45°: 44,5 / 43 mm 48°: 42 / 41 mm
Voľnobežné otáčky / min <sup>-1</sup>	6.000
Rozmery	348×210×290 mm
Hmotnosť	4,5 – 5,1 kg

Pripojenie na lištu bez adaptéru áno

**DHS783T2JU**  
1 027,99 €

**DHS783ZU**  
519,99 €

**DHS782PT2J**  
831,99 €

**DHS782Z**  
411,99 €

▲ DHS783

## Aku kotúčová píla

DHS710 190 mm

Li-ion



18V



Priemer kotúča	190 / 185 mm
Max rezný výkon	90°: 68,5 / 66 mm 45°: 49 / 47,5 mm 50°: 44 / 42,5 mm
Voľnobežné otáčky / min <sup>-1</sup>	4.800
Vibrácie	Rez do dreva: 2,5 m/s <sup>2</sup>
Úroveň akustického tlaku	85 dB(A)
Úroveň akustického výkonu	96 dB(A)
Rozmery	356x217x298 mm
Hmotnosť	3,9 – 4,6 kg

Pripojenie na lištu s adaptérom 197252-3

DHS710PT2J  
648,99 €DHS710Z  
279,99 €

## Aku ponorná píla

DSP600

Li-ion



18V



Priemer kotúča	165 mm
Max rezný výkon	90°: 56 mm 45°: 40 mm 48°: 38 mm
Voľnobežné otáčky / min <sup>-1</sup>	2.500 – 6.300
Vibrácie	2,5 m/s <sup>2</sup>
Úroveň akustického tlaku	92 dB(A)
Úroveň akustického výkonu	103 dB(A)
Rozmery	346x241x272 mm
Hmotnosť	4,4 – 5,1 kg

Pripojenie na lištu bez adaptéru áno

DSP600ZJ  
509,99 €

## Aku ponorná píla

DSP601 165 mm

Li-ion

AWS BL ADT  
MOTOR

▲ DSP601

18V



Priemer kotúča	165 mm
Max rezný výkon	90°: 56 mm 45°: 40 mm 48°: 38 mm
Voľnobežné otáčky / min <sup>-1</sup>	2.500 – 6.300
Vibrácie	2,5 m/s <sup>2</sup>
Úroveň akustického tlaku	92 dB(A)
Úroveň akustického výkonu	103 dB(A)
Rozmery	346x241x272 mm
Hmotnosť	4,4 – 5,1 kg

Pripojenie na lištu bez adaptéru áno

DSP601ZJU  
584,99 €

## Aku rezač na železo

DLW140 355 mm

Li-ion



18V



Priemer rezného kotúča	355 mm
Vítanie kotúča	25,4 mm
Voľnobežné otáčky	3.800
Max. výkon	1.300 W
Vibrácie	2,5 m/s <sup>2</sup>
Úroveň akustického tlaku	103 dB(A)
Úroveň akustického výkonu	115 dB(A)
Rozmery	537x290x640 mm
Hmotnosť	17,2 – 17,8 kg

DLW140Z  
459,99 €

## Aku chvostová píla

DJR360

Li-ion

BL XPT LXT  
EXTREME PROTECTION TECHNOLOGY

18V



Dĺžka kmitu	32 mm
Kmity / min	Max/min: 0 – 3.000 / 0 – 2.300
Max. rezný výkon	Rúra: 130 mm Drevo: 255 mm
Úroveň akustického tlaku	85 dB(A)
Úroveň akustického výkonu	96 dB(A)
Rozmery	449x116x243 mm
Hmotnosť	4,0 – 4,7 kg

DJR360PT2  
717,99 €

## Aku fukár / vysávač

DUB363

Li-ion



18V



Max. prietok vzduchu	13,4 m³/min (473 CFM)
Max. rýchlosť vzduchu	65 m/s
Voľnobežné otáčky / min⁻¹	0 – 7.850
Hmotnosť	4,3 – 6,6 kg

DUB363PT2V  
634,99 €

DUB363ZV  
324,99 €

## Aku fukár

DUB362

Li-ion



18V



Max. prietok vzduchu	13,4 m³/min (473 CFM)
Max. rýchlosť vzduchu	54 m/s (120 MPH)
Voľnobežné otáčky / min⁻¹	11.400 – 21.500
Úroveň akustického tlaku	79,1 dB(A)
Úroveň akustického výkonu	93,5 dB(A)
Vibrácie	2,5 m/s²
Rozmery	830/880/930×205×295 mm
Hmotnosť	3,5 – 4,2 kg

DUB362Z  
279,99 €

## Aku fukár

DUB361

Li-ion



18V



Max. prietok vzduchu	Max: 4,4 m³/min (155 CFM)
	Min: 2,6 m³/min (92 CFM)
Max. rýchlosť vzduchu	Max: 93 m/s (208 MPH)
	Min: 57 m/s (128 MPH)
Voľnobežné otáčky / min⁻¹	Max: 17.000
	Min: 10.000
Úroveň akustického tlaku	82,3 dB(A)
Úroveň akustického výkonu	94,7 dB(A)
Vibrácie	2,5 m/s²
Rozmery	905×141×194 mm
Hmotnosť	3,1 – 3,2 kg

DUB361Z  
176,99 €

## Aku tlakový čistič

DHW080

Li-ion



18V



Max. prítok vody	6,3 l/min
Max. prietok vody	Max 5,5 / min 4,0 l/min
Max. tlak	8 Mpa
Pracovný tlak	Max 5,5 / min 3,0 Mpa
Max. teplota privádzanej vody	40 °C
Max. dĺžka prísávania vody	1 m
Dĺžka vysokotlakovej hadice	5 m
Úroveň akustického tlaku	70,9 dB(A)
Rozmery	438×218×269 mm
Hmotnosť	7,1 – 7,7 kg

DHW080ZK  
663,99 €

## Aku krovinoz

DUR369A

Li-ion



18V



Rezná šírka	Kovový žací nôž: 255 mm
	Žacia hlava 430 mm
	Plastový nôž 305 mm
Voľnobežné otáčky / min⁻¹	Max/priemer/min
	3.300 – 7.000 / 5.500 / 4.600
Uchytenie na vretene	M10 × 1,25 LH
Rozmery	1.846×628×530 mm
Hmotnosť	6,0 – 6,6 kg

DUR369AZ  
422,99 €



## Aku krovinořez

DUR368A

Li-ion



18V



Rezná šířka	Kovový žací nůž: 255 mm
	Žací hlava 350 mm
	Plastový nůž 255 mm
Voľnobežné otáčky / min <sup>-1</sup>	Max/priemer/min 6.500 / 5.300 / 3.500
Uchytenie na vretene	M10 x 1,25 LH
Rozmery	1.758x615x442 mm
Hmotnosť	4,1 – 4,7 kg

DUR368APT2  
655,99 €DUR368AZ  
348,99 €

## Aku nožnice na vinič

DUP362

Li-ion



18V



Max. rezný výkon	33 mm
Max. strižná sila	250 N
Uroveň akustického tlaku	70 dB(A)
Rozmery	305x43x106 mm
Hmotnosť	0,8 kg

DUP362PT2  
1 663,99 €DUP362Z  
1 406,99 €

## Aku vyvetvovacia píla

DUA300

Li-ion



18V



Dĺžka lišty	300 mm
Typ reťaze	1,1 / 1,3
Delenie reťaze	3/8"
Rýchlosť reťaze	0 – 20 m/s
Objem nádrže na oleja	160 ml
Hmotnosť	6,1 – 6,9 kg
Dĺžka	2,26 m

DUA300Z  
522,99 €

## Aku vyvetvovacia píla (teleskopická)

DUA301Z

NOVINKA

Li-ion



18V



Dĺžka lišty	300 mm
Delenie reťaze	3/8"
Šírka drážky	1,1 – 1,3 mm
Rýchlosť reťaze	0 – 20 m/s (0 – 1.200 m/min)
Nádrž na olej	160 mL
Rozmery	2.530 – 3.762 x 155 x 191 mm
Hmotnosť	7,8 - 8,5 kg

DUA301Z  
691,99 €

## Aku krovinořez

DUX60Z

Li-ion



18V



Voľnobežné otáčky	Max: 0 – 9.700 Stredné: 0 – 8.200 Min: 0 – 5.700
Rozmery	1.011x320x216 mm
Hmotnosť	4,1 – 8,7 kg

DUX60ZM4  
442,99 €

## Aku plotostrih

DUH651

Li-ion



18V



Dĺžka noža	650 mm
Počet strihov / min	1.800
Hmotnosť	4,7 – 5,5 kg

DUH651Z  
332,99 €

## Aku kosačka

DLM382

Li-ion



18V



Šírka noža	380 mm
Výška kosenia	20 – 75 mm
Voľnobežné otáčky / min <sup>-1</sup>	3.700
Objem zberného koša	40 L
Rozmery	1.380 – 1.410×450×985 – 1.005 mm
Hmotnosť	16,2 – 16,9 kg

DLM382PT2  
571,99 €

DLM382CM2  
487,99 €

DLM382Z  
354,99 €

## Aku kosačka

DLM432

Li-ion



18V



Šírka noža	430 mm
Výška kosenia	20 – 75 mm
Voľnobežné otáčky / min <sup>-1</sup>	3.600
Objem zberného koša	50 L
Rozmery	1.435 – 1.490×460×1.005 – 1.045 mm
Hmotnosť	16,8 – 17,5 kg

DLM432PT2  
609,99 €

DLM432Z  
389,99 €

## Aku kosačka

DLM465

NOVINKA

Li-ion



18V

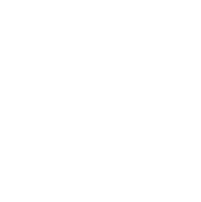

Šírka noža	460 mm
Výška kosenia	20 – 100 mm
Voľnobežné otáčky / min <sup>-1</sup>	2.500
Objem zberného koša	60 L
Rýchlosť pohonu	2,5 – 5,0 km/h
Rozmery	1.610 – 1.690 × 535 × 980 – 1.095 mm
Hmotnosť	35,3 – 39 kg

DLM465Z  
1 029,99 €

## Aku kosačka

DLM480

NOVINKA

Li-ion



18V



Šírka noža	480 mm
Výška kosenia	20 – 100 mm
Voľnobežné otáčky / min <sup>-1</sup>	3.100
Objem zberného koša	62 L
Rozmery	1.690 – 1.740×530×930 – 1.060 mm
Hmotnosť	24,5 – 26,8 kg

DLM480CT2  
779,99 €

DLM480Z  
561,99 €

## Aku kosačka

DLM481

NOVINKA

Li-ion



Šírka noža	480 mm
Výška kosenia	20 – 100 mm
Voľnobežné otáčky / min <sup>-1</sup>	3.100
Rýchlosť pohonu	2,5 – 5,0 km/h
Objem zberného koša	62 L
Rozmery	1.690 – 1.740×530×930 – 1.060 mm
Hmotnosť	27,1 – 29,3 kg

18V

**LXT BL XPT**  
 MOTOR EXTREME PROTECTION TECHNOLOGY

**DLM481CT2**  
 894,99 €

**DLM481Z**  
 675,99 €

## Aku kosačka

DLM532 / DLM533

Li-ion



Šírka noža	534 mm
Výška kosenia	20 – 100 mm
Voľnobežné otáčky / min <sup>-1</sup>	2.500 – 3.300 – DLM530 / DLM532 2.300 – 2.800 – DLM533
Objem zberného koša	70 L
Rýchlosť pohonu	2,5 – 5,0 km/hod
Počet slotov na akumulátory	4
Rozmery	1.630 – 1.715×590×990 – 1.190 mm
Hmotnosť	DLM532: 39,1 – 42,9 kg DLM533: 43,9 – 47,9 kg

18V

**LXT BL XPT**  
 MOTOR EXTREME PROTECTION TECHNOLOGY

**DLM532ZX2**  
 1 129,99 €

**DLM533ZX2**  
 1 329,99 €

## Aku kosačka

DLM537

NOVINKA

Li-ion



Šírka noža	534 mm
Výška kosenia	20 – 100 mm
Voľnobežné otáčky / min <sup>-1</sup>	2.800
Objem zberného koša	70 L
Rýchlosť pohonu	2,5 – 5,0 km/h
Rozmery	1.655 – 1.740 × 590 × 990 – 1.100 mm
Hmotnosť	42,8 – 46,7 kg

18V

**LXT BL XPT**  
 MOTOR EXTREME PROTECTION TECHNOLOGY

**DLM537Z**  
 1 299,99 €

## Aku kosačka

DLM538

NOVINKA

Li-ion



Šírka noža	534 mm
Výška kosenia	20 – 100 mm
Voľnobežné otáčky / min <sup>-1</sup>	3.000
Objem zberného koša	70 L
Rozmery	1.810 – 1.870×580×920 – 1.040 mm
Hmotnosť	25,5 – 28,0 kg

18V

**LXT BL XPT**  
 MOTOR EXTREME PROTECTION TECHNOLOGY

**DLM538CT2**  
 831,99 €

**DLM538Z**  
 613,99 €

## Aku kosačka

DLM539

NOVINKA

Li-ion



Šírka noža	534 mm
Výška kosenia	20 – 100 mm
Voľnobežné otáčky / min <sup>-1</sup>	3.000
Rýchlosť pohonu	2,5 – 5,0 km/h
Objem zberného koša	70 L
Rozmery	1.810 – 1.870×580×920 – 1.040 mm
Hmotnosť	27,9 – 30,4 kg

18V

**LXT BL XPT**  
 MOTOR EXTREME PROTECTION TECHNOLOGY

**DLM539CT2**  
 935,99 €

**DLM539Z**  
 727,99 €



## Aku pôdny vrták

DDG460

Li-ion



18V



Max. výkon:	Piesočnatá zem: 200 mm
	Hlinitá zem: 150 mm
Voľnobežné otáčky:	Max/min: 0 – 1 400 / 0 – 350
Max. ťahovací moment:	Max 136 Nm / min 48 Nm
Hmotnosť:	7,3 – 8,2 kg

**ADT**  
**LXT BL XPT**  
MOTOR EXTREME PROTECTION TECHNOLOGY

**DDG460ZX7**  
**703,99 €**

## Aku kosačka

LM001C

NOVINKA

Li-ion



18V



Šírka noža	534 mm
Výška kosenia	20 – 100 mm
Voľnobežné otáčky / min <sup>-1</sup>	2.300 – 2.800
Objem zberného koša	70 L
Rýchlosť pohonu	2,5 – 5,0 km/h
Rozmery	1.630 – 1.715×590×990 – 1.095 mm
Hmotnosť	42,1 – 49,5 kg

Ku stroju je potrebné dokúpiť PDC1200 alebo PDC01

**LM001CZ**  
**1 247,99 €**

## Aku krovinoz

UR101CZ

Li-ion



18V



Rezná šírka	Kovový žací nůž: 255 mm
	Žacia hlava 430 mm
	Plastový nůž 255 mm
Voľnobežné otáčky / min <sup>-1</sup>	Max/priemer/min
	0 – 7.000 / 5.500 / 4.600
Uchytenie na vretene	M10 × 1,25 LH
Rozmery	1.760×628×550 mm
Hmotnosť	5,4 kg

Ku stroju je nutné prikúpiť PDC01 alebo PDC1200

**UR101CZ**  
**623,99 €**

## Aku fukár

UB001CZ

Li-ion



18V



Max. prietok vzduchu	17,6 m <sup>3</sup> /min
Max. rýchlosť vzduchu	70 m/s
Voľnobežné otáčky / min <sup>-1</sup>	24 000
Hmotnosť	2,6 – 2,9 kg

Ku stroju je nutné prikúpiť PDC01 alebo PDC1200

**UB001CZ**  
**353,99 €**

## Aku ťahovač

DWT310

Li-ion



18V



Max. vrtací výkon	Vysokopevnostné skrutky (HTB)
	M16, M20, M22,
	Super vysokopevnostné skrutky (HTB)
	M16, M20
Upínanie	3/4"
Voľnobežné otáčky min <sup>-1</sup>	14
Max. ťahovací moment	804 n.m
Úroveň akustického tlaku	83 dB(A)
Úroveň akustického výkonu	94 dB(A)
Rozmery	296×130×377 mm
Hmotnosť	6,5 – 7,1 kg

**DWT310ZK**  
**2 055,99 €**

# 18V LITHIUM-ION



18V Lithium-ion

# LXT





18V x2

**380+**  
**STROJOV**

6.0Ah 5.0Ah 4.0Ah  
3.0Ah 2.0Ah 1.5Ah

*Rozšírte si svoj Li-Ion sortiment*



## Aku kosačka

DLM330

NOVINKA

Li-ion



Šírka noža	330 mm
Výška kosenia	20 – 75 mm
Voľnobežné otáčky / min <sup>-1</sup>	4.300
Objem zberného koša	30 L
Rozmery	1.285 – 1.350 × 375 × 935 – 1.035 mm
Hmotnosť	11,6 – 12,5 kg

18V

**LXT XPT**  
 EXTREME PROTECTION TECHNOLOGY

**DLM330ST**  
 353,99 €

**DLM330Z**  
 228,99 €

## Aku ťahovač

DDF486

NOVINKA

Li-ion



Max. vrtací výkon	Železo: 13 mm
	Drevo: 50 mm
Voľnobežné otáčky / min <sup>-1</sup>	Max: 0 – 2.100
	Min: 0 – 550
Max. ťahovací moment	125 N·m
Rozmery	178×81×217 mm
Hmotnosť	2,3 – 2,6 kg

18V

**LXT BL MOTOR XPT**  
 EXTREME PROTECTION TECHNOLOGY

**DDF486RTJ**  
 486,99 €

**DDF486Z**  
 279,99 €

## Aku skrutkovač

DDF458 13 mm

Li-ion



Max. vrtací výkon	Železo: 13 mm
	Drevo: 76 mm
Voľnobežné otáčky / min <sup>-1</sup>	Max: 0 – 2.000
	Min: 0 – 400
Max. ťahovací moment	Tvrдый / mäkký spoj: 91 / 58 N·m
Max. povoľovací moment	84 N·m
Rozmery	225×79×259 mm
Hmotnosť	2,1 – 2,5 kg

18V

**LXT XPT**  
 EXTREME PROTECTION TECHNOLOGY

DDF458RF3J – 3 ks akumulátorov

**DDF458RF3J**  
 515,99 €

**DDF458Z**  
 155,99 €

## Aku skrutkovač

DDF482 13 mm

Li-ion



Max. vrtací výkon	Železo / Drevo: 13 / 38 mm
Rozsah skľučovadla	1,5 – 13 mm
Voľnobežné otáčky / min <sup>-1</sup>	Max / Min: 0 – 1.900 / 0 – 600
Max. ťahovací moment	Tvrдый / mäkký spoj: 62 / 36 N·m
Max. povoľovací moment	54 N·m
Vibrácie	Vrtanie do železa: 2,5 m/s <sup>2</sup>
Úroveň akustického tlaku	75 dB(A)
Rozmery	185×79×249 mm
Hmotnosť	1,5 – 1,8 kg

18V

**LXT XPT**  
 EXTREME PROTECTION TECHNOLOGY

**DDF482RFEB**  
 311,99 €

**DDF482RFJ**  
 324,99 €

**DDF482Z**  
 108,99 €

B – čierne prevedenie stroja

## Aku skrutkovač

DDF484 13 mm

Li-ion



Max. vrtací výkon	Železo / Drevo: 13 / 38 mm
Rozsah skľučovadla	1,5 – 13 mm
Voľnobežné otáčky / min <sup>-1</sup>	Max / Min: 0 – 2.000 / 0 – 500
Max. ťahovací moment	Tvrдый / mäkký spoj: 54 / 30 N·m
Max. povoľovací moment	60 N·m
Vibrácie	Vrtanie do železa: 2,5 m/s <sup>2</sup>
Úroveň akustického tlaku	76 dB(A)
Rozmery	172×79×261 mm
Hmotnosť	1,5 – 1,8 kg

18V

**LXT BL MOTOR XPT**  
 EXTREME PROTECTION TECHNOLOGY

**DDF484RFJ**  
 332,99 €

**DDF484Z**  
 151,99 €

**Aku skrutkovač**

**DDF485** 13 mm

**Li-ion**



18V



Max. vrtací výkon	Železo / drevo 13 / 38 mm
Rozsah skľučovadla	1,5 – 13 mm
Voľnobežné otáčky / min <sup>-1</sup>	Max: 0 – 1.900 Min: 0 – 500
Max. ťahovací moment	Tvrдый / mäkký spoj 50 / 27 Nm
Max. povoľovací moment	50 Nm
Vibrácie	Vrtanie do železa: 2,5 m/s <sup>2</sup>
Úroveň akustického tlaku	74 dB (A)
Hmotnosť	1,4 – 1,7 kg

**LXT BL XPT**  
MOTOR EXTREME PROTECTION TECHNOLOGY

**DDF485RFJ**  
301,99 €

**DDF485Z**  
135,99 €

**DDF485RAJ**  
269,99 €

**DDF485RTJ**  
335,99 €

**Aku skrutkovač**

**DDF453** 13 mm

**Li-ion**



18V



Max. vrtací výkon	Železo: 13 mm Drevo: 36 mm
Rozsah skľučovadla	1,5 – 13 mm
Voľnobežné otáčky / min <sup>-1</sup>	Max: 0 – 1.300 Min: 0 – 400
Max. ťahovací moment	Tvrдый / mäkký spoj: 42 / 27 N·m
Max. povoľovací moment	38 N·m
Rozmery	222×79×244 mm
Hmotnosť	1,7 – 2,0 kg

**LXT**

**DDF453RFE**  
248,99 €

**DDF453SFX1**  
291,99 €

**DDF453SYE**  
216,99 €

**DDF453SYX4**  
187,99 €

**DDF453SYX5**  
135,99 €

X1 – extra sada príslušenstva

**Aku skrutkovač**

**DDF487**

**NOVINKA**

**Li-ion**



18V



Max. vrtací výkon	Železo: 13 mm Drevo: 36 mm
Voľnobežné otáčky / min <sup>-1</sup>	Max: 0 – 1.700 Min: 0 – 500
Max. ťahovací moment	40 N·m
Rozmery	164×81×232 mm
Hmotnosť	1,4 – 1,7 kg

**BL XPT**  
MOTOR EXTREME PROTECTION TECHNOLOGY

**DDF487RAJ**  
311,99 €

**DDF487Z**  
135,99 €

**Aku skrutkovač**

**DDF083** 13 mm

**Li-ion**



18V



Max. vrtací výkon	Železo / Drevo: 13 / 36 mm
Upínanie	1/4"
Voľnobežné otáčky / min <sup>-1</sup>	Max / Min: 0 – 1.700 / 0 – 500
Max. ťahovací moment	Tvrдый / mäkký spoj: 40 / 23 N·m
Max. povoľovací moment	40 N·m
Vibrácie	Vrtanie do železa: 2,5 m/s <sup>2</sup>
Úroveň akustického tlaku	77 dB(A)
Rozmery	124×79×247 mm
Hmotnosť	1,1 – 1,4 kg

**LXT BL XPT**  
MOTOR EXTREME PROTECTION TECHNOLOGY

**DDF083Z**  
139,99 €

**Aku skrutkovač**

**DHP486**

**NOVINKA**

**Li-ion**



18V



Max. vrtací výkon	Železo: 13 mm Drevo: 50 mm Murivo: 16 mm
Voľnobežné otáčky / min <sup>-1</sup>	Max: 0 – 2.100 Min: 0 – 550
Počet úderov za minútu	Max: 0 – 31.500 Min: 0 – 8.250
Max. ťahovací moment	125 N·m
Rozmery	178×81×217 mm
Hmotnosť	2,3 – 2,7 kg

**BL XPT**  
MOTOR EXTREME PROTECTION TECHNOLOGY

**DHP486RTJ**  
519,99 €

**DHP486Z**  
301,99 €

## Aku skrutkovač s príklepom

DHP458 13 mm

Li-ion



18V



Max. vrtací výkon	Železo: 13 mm Drevo: 76 mm Murivo: 16 mm
Voľnobežné otáčky / min <sup>-1</sup>	Max: 0 – 2.000 Min: 0 – 400
Počet úderov za minútu	Max: 0 – 30.000 Min: 0 – 6.000
Max. ťahovací moment	Tvrдый / mäkký spoj: 91 / 58 N·m
Max. povoloovací moment	84 N·m
Rozmery	225×79×259 mm
Hmotnosť	2,2 – 2,6 kg

LXT XPT  
EXTREME PROTECTION TECHNOLOGYDHP458RTJ  
432,99 €DHP458Z  
176,99 €

## Aku skrutkovač s príklepom

DHP482 13 mm

Li-ion



18V



Max. vrtací výkon	Železo / Drevo / Murivo: 13 / 38 / 13 mm
Rozsah skľučovadla	1,5 – 13 mm
Počet úderov za minútu	Max / Min: 0 – 28.500 / 0 – 9.000
Voľnobežné otáčky / min <sup>-1</sup>	Max / Min: 0 – 1.900 / 0 – 600
Max. ťahovací moment	Tvrдый / mäkký spoj: 62 / 36 N·m
Vibrácie	Vrtanie s príklepom do betónu: 6,0 m/s <sup>2</sup>
Rozmery	198×79×249 mm
Hmotnosť	1,5 – 1,8 kg

LXT XPT  
EXTREME PROTECTION TECHNOLOGYDHP482RFJ  
324,99 €DHP482Z  
119,99 €

## Aku skrutkovač s príklepom

DHP484 13 mm

Li-ion



18V



Max. vrtací výkon	Železo / Drevo / Murivo: 13 / 38 / 13 mm
Rozsah skľučovadla	1,5 – 13 mm
Počet úderov za minútu	Max / Min: 0 – 30.000 / 0 – 7.500
Voľnobežné otáčky / min <sup>-1</sup>	Max / Min: 0 – 2.000 / 0 – 500
Max. ťahovací moment	Tvrдый / mäkký spoj: 54 / 30 N·m
Max. povoloovací moment	60 N·m
Vibrácie	Vrtanie s príklepom do betónu: 8,0 m/s <sup>2</sup> Vrtanie do železa: 2,5 m/s <sup>2</sup>
Úroveň akustického tlaku	88 dB(A)
Úroveň akustického výkonu	99 dB(A)
Rozmery	182×79×261 mm
Hmotnosť	1,6 – 1,9 kg

LXT BL MOTOR XPT  
EXTREME PROTECTION TECHNOLOGYDHP484RFJ  
357,99 €DHP484Z  
173,99 €

## Aku skrutkovač s príklepom

DHP485 13 mm

Li-ion



18V



Max. vrtací výkon	Železo / drevo / murivo 13 / 38 / 13 mm
Rozsah skľučovadla	1,5 – 13 mm
Počet úderov za minútu	Max/min 0 – 28.500 / 0 – 7.500
Voľnobežné otáčky / min <sup>-1</sup>	Max: 0 – 1.900 Min: 0 – 500
Max. ťahovací moment	Tvrдый / mäkký spoj 50 / 27 Nm
Max. povoloovací moment	50 Nm
Vibrácie	Vrtanie do betónu: 8,0 m/s <sup>2</sup>
Úroveň akustického tlaku	82 dB (A)
Úroveň akustického výkonu	93 dB (A)
Hmotnosť	1,5 – 1,8 kg

LXT BL MOTOR XPT  
EXTREME PROTECTION TECHNOLOGYDHP485RFJ  
311,99 €DHP485Z  
145,99 €DHP485RF3J  
353,99 €

## Aku skrutkovač s príklepom

DHP453 13 mm

Li-ion



18V



Max. vrtací výkon	Železo: 13 mm Drevo: 36 mm Murivo: 13 mm
Počet úderov za minútu	Max: 0 – 19.500 Min: 0 – 6.000
Voľnobežné otáčky / min <sup>-1</sup>	Max: 0 – 1.300 Min: 0 – 400
Max. ťahovací moment	Tvrдый / mäkký spoj: 42 / 27 N·m
Max. povoloovací moment	38 N·m
Rozmery	240×79×244 mm
Hmotnosť	1,7 – 2,0 kg

LXT

DHP453RFE  
279,99 €DHP453SYE  
234,99 €DHP453RFX8  
166,99 €



**Aku skrutkovač s príklepom**
**DHP487**
**NOVINKA**
**Li-ion**

**18V**

**LXT BL XPT**  
 MOTOR EXTREME PROTECTION TECHNOLOGY

Max. vrtací výkon	Železo: 13 mm Drevo: 36 mm Murivo: 13 mm
Voľnobežné otáčky / min <sup>-1</sup>	Max: 0 – 1.700 Min: 0 – 500
Počet úderov za minútu	Max: 0 – 25.500 Min: 0 – 7.500
Max. ťahovací moment	40 N.m
Rozmery	164x81x232 mm
Hmotnosť	1,4 – 1,7 kg

**DHP487RAJ**  
 357,99 €

**DHP487Z**  
 139,99 €

**Aku rázový skrutkovač**
**DTD172**
**NOVINKA**
**Li-ion**

**18V**

**LXT BL XPT**  
 MOTOR EXTREME PROTECTION TECHNOLOGY

Max. vrtací výkon	Skrutka so šesťhrannou hlavou: M4 – M8 Skrutka štandardná: M5 – M16 Skrutka vysokopevnostná: M5 – M14
Upínanie	1/4"
Počet úderov za minútu	Max / Tvrdý / Priemer / Min / Drevo / Skrutka / T (1) / T (2) mód 0 – 3.600 / 3.200 / 2.100 / 1.100 / 1.800 / 3.600 / 2.900 / 3.600
Max. ťahovací moment	Max / Tvrdý / Priemer / Min / Drevo / Skrutka / T (2) mód 0 – 3.800 / 3.600 / 2.600 / 1.100 / 3.800 / 3.800 / 2.600
Vibrácie	180 Nm
Rozmery	114 x 81 x 236 mm
Hmotnosť	1,2 – 1,5 kg

**DTD172RTJ**  
 Cena na vyziadanie

**DTD172Z**  
 Cena na vyziadanie

**Aku rázový skrutkovač**
**DTD171 1/4"**
**Li-ion**

**18V**

**LXT BL XPT**  
 MOTOR EXTREME PROTECTION TECHNOLOGY

Max. vrtací výkon	Skrutka so šesťhrannou hlavou: M4 – M8 Skrutka štandardná: M5 – M16 Skrutka vysokopevnostná: M5 – M14
Upínanie	1/4"
Voľnobežné otáčky min <sup>-1</sup>	Max / Tvrdý / Priemer / Min / Drevo / Skrutka / T (1) / T (2) mód 0 – 3.600 / 3.200 / 2.100 / 1.100 / 1.800 / 3.600 / 2.900 / 3.600
Počet úderov za minútu	Max / Tvrdý / Priemer / Min / Drevo / Skrutka / T (2) mód 0 – 3.800 / 3.600 / 2.600 / 1.100 / 3.800 / 3.800 / 2.600
Max. ťahovací moment	180 Nm
Vibrácie	13,5 m/s <sup>2</sup>
Úroveň akustického tlaku	97 dB (A)
Úroveň akustického výkonu	108 dB (A)
Rozmery	116x79x236 mm
Hmotnosť	1,2 – 1,6 kg

**DTD171RTJ**  
 508,99 €

**DTD171Z**  
 205,99 €

**Aku rázový skrutkovač**
**DTD157 1/4"**
**NOVINKA**
**Li-ion**

**18V**

**LXT BL XPT**  
 MOTOR EXTREME PROTECTION TECHNOLOGY

Max. vrtací výkon	Skrutka so šesťhrannou hlavou: M4 – M8 Skrutka štandardná: M5 – M14 Skrutka vysokopevnostná: M5 – M12
Upínanie	1/4"
Voľnobežné otáčky min <sup>-1</sup>	Max / Min: 0 – 3.000 / 0 – 1.300
Počet úderov za minútu	Max / Min: 0 – 4.100 / 0 – 2.000
Max. ťahovací moment	140 N.m
Rozmery	133x81x185 mm
Hmotnosť	1,2 – 1,5 kg

**DTD157Z**  
 145,99 €

**Aku rázový skrutkovač**
**DTD156 1/4"**
**Li-ion**

**18V**

**LXT**

Max. vrtací výkon	Skrutka so šesťhrannou hlavou: M4 – M8 Skrutka štandardná: M5 – M14 Skrutka vysokopevnostná: M5 – M12
Upínanie	1/4"
Voľnobežné otáčky min <sup>-1</sup>	0 – 2.500
Počet úderov za minútu	0 – 3.500
Max. ťahovací moment	155 N.m
Rozmery	143x79x241 mm
Hmotnosť	1,3 – 1,6 kg

**DTD156RTJ**  
 399,99 €

**DTD156Z**  
 93,99 €

## Aku rázový skrutkovač

DTD154 1/4"

Li-ion



18V



Max. vrtací výkon	Skrutka so šesťhrannou hlavou: M4 – M8 Skrutka štandardná: M5 – M16 Skrutka vysokopevnostná: M5 – M14
Upínanie	1/4"
Voľnobežné otáčky / min <sup>-1</sup>	Max / Tvrdý / Priemer / Mäkký / Tmode 0 – 3.600 / 0 – 2.100 / 0 – 1.100
Počet úderov za minútu	Max / Tvrdý / Priemer / Mäkký / Tmode 0 – 3.800 / 0 – 2.600 / 0 – 1.100
Max. uťahovací moment	175 N·m
Vibrácie	12,5 m/s <sup>2</sup>
Úroveň akustického tlaku	96 dB(A)
Úroveň akustického výkonu	107 dB(A)
Rozmery	117×79×236 mm
Hmotnosť	1,3 – 1,6 kg

**DTD154RTJ**  
465,99 €

**DTD154Z**  
187,99 €

**LXT BL XPT**  
MOTOR  
EXTREME PROTECTION TECHNOLOGY

## Aku rázový skrutkovač

DTD153 1/4"

Li-ion



18V



Max. vrtací výkon	Skrutka so šesťhrannou hlavou: M4 – M8 Skrutka štandardná: M5 – M16 Skrutka vysokopevnostná: M5 – M14
Upínanie	1/4"
Voľnobežné otáčky / min <sup>-1</sup>	0 – 3.400
Počet úderov za minútu	0 – 3.600
Max. uťahovací moment	170 N·m
Vibrácie	13,0 m/s <sup>2</sup>
Úroveň akustického tlaku	96 dB(A)
Úroveň akustického výkonu	107 dB(A)
Rozmery	126×79×238 mm
Hmotnosť	1,3 – 1,6 kg

**DTD153RFJ**  
415,99 €

**DTD153Z**  
166,99 €

**LXT BL XPT**  
MOTOR  
EXTREME PROTECTION TECHNOLOGY

## Aku rázový skrutkovač

DTD152 1/4"

Li-ion



18V



Max. vrtací výkon	Skrutka so šesťhrannou hlavou: M4 – M8 Skrutka štandardná: M5 – M16 Skrutka vysokopevnostná: M5 – M12
Upínanie	1/4"
Voľnobežné otáčky / min <sup>-1</sup>	0 – 2.900
Počet úderov za minútu	0 – 3.500
Max. uťahovací moment	165 N·m
Vibrácie	10,5 m/s <sup>2</sup>
Úroveň akustického tlaku	93 dB(A)
Úroveň akustického výkonu	104 dB(A)
Rozmery	137×79×238 mm
Hmotnosť	1,3 – 1,6 kg

**DTD152RTJ**  
324,99 €

**DTD152Z**  
108,99 €

**LXT XPT**  
EXTREME PROTECTION TECHNOLOGY

## Aku olejovo pulzný skrutkovač

DTS141

Li-ion



18V



Max. vrtací výkon	Skrutka so šesťhrannou hlavou: M4 – M8 Skrutka štandardná: M5 – M8 Skrutka vysokopevnostná: M5 – M6
Voľnobežné otáčky / min <sup>-1</sup>	Max.: 0 – 3.200 Priemer: 0 – 2.000 Min.: 0 – 1.200
Počet úderov za minútu	Tvrdý spoj: 0 – 2.700 Stredný spoj: 0 – 2.200 Mäkký spoj: 0 – 1.400
Max. uťahovací moment	40 N·m
Hlučnosť	77 dB(A)
Rozmery	136×79×240 mm
Hmotnosť	1,3 – 1,6 kg

**DTS141Z**  
422,99 €

**LXT BL XPT**  
MOTOR  
EXTREME PROTECTION TECHNOLOGY

## Aku rázový uťahovač

DTW1001 3/4"

Li-ion



18V



Max. uťahovací výkon	Skrutka štandardná: M12 – M30 Skrutka vysokopevnostná: M10 – M24
Upínanie	3/4"
Voľnobežné otáčky / min <sup>-1</sup>	Tvrdý / stredný / mäkký spoj: 0 – 1.800 / 0 – 1.000 / 0 – 900
Počet úderov za minútu	Tvrdý / stredný / mäkký spoj: 0 – 2.200 / 0 – 2.000 / 0 – 1.800
Max. uťahovací moment	1.050 N·m
Vibrácie	15,5 m/s <sup>2</sup>
Úroveň akustického tlaku	98 dB(A)
Úroveň akustického výkonu	109 dB(A)
Rozmery	229×91×289 mm
Hmotnosť	3,4 – 3,7 kg

**DTW1001RTJ**  
724,99 €

**DTW1001Z**  
384,99 €

**LXT BL**  
MOTOR

## Aku rázový uťahovač

DTW1002 1/2"

Li-ion



18V



Max. uťahovací výkon	Skrutka štandardná: M12 – M30 Skrutka vysokopevnostná: M10 – M24
Upínanie	1/2"
Voľnobežné otáčky / min <sup>-1</sup>	Tvrdý / stredný / mäkký spoj: 0 – 1.800 / 0 – 1.000 / 0 – 900
Počet úderov za minútu	Tvrdý / stredný / mäkký spoj: 0 – 2.200 / 0 – 2.000 / 0 – 1.800
Max. uťahovací moment	1.000 N·m
Vibrácie	18,0 m/s <sup>2</sup>
Úroveň akustického tlaku	97 dB(A)
Úroveň akustického výkonu	108 dB(A)
Rozmery	229×91×289 mm
Hmotnosť	3,3 – 3,6 kg

LXT BL MOTOR

DTW1002RTJ  
703,99 €

DTW1002Z  
374,99 €

## Aku rázový uťahovač

DTW300 1/2"

Li-ion



18V



Max. uťahovací výkon	Štandardná skrutka: M10 – M20 Vysokopevnostná skrutka: M10 – M16
Upínanie	1/2" Krúžok
Voľnobežné otáčky / min <sup>-1</sup>	0 – 3.200 / 0 – 2.600 / 0 – 1.800 / 0 – 1.000
Počet úderov za minútu	0 – 4.000 / 0 – 3.400 / 0 – 2.600 / 0 – 1.800
Max. uťahovací moment	330 N·m
Vibrácie	12,5 m/s <sup>2</sup>
Úroveň akustického tlaku	97 dB(A)
Úroveň akustického výkonu	108 dB(A)
Hmotnosť	1,5 – 1,8 kg

LXT BL XPT MOTOR EXTREME PROTECTION TECHNOLOGY

DTW300RTJ  
539,99 €

DTW300Z  
259,99 €

## Aku rázový uťahovač

DTW301 1/2"

Li-ion



18V



Max. uťahovací výkon	Štandardná skrutka: M10 – M20 Vysokopevnostná skrutka: M10 – M16
Upínanie	1/2"
Voľnobežné otáčky / min <sup>-1</sup>	0 – 3.200 / 0 – 2.600 / 0 – 1.800 / 0 – 1.000
Počet úderov za minútu	0 – 4.000 / 0 – 3.400 / 0 – 2.600 / 0 – 1.800
Max. uťahovací moment	330 N·m
Vibrácie	12,5 m/s <sup>2</sup>
Úroveň akustického tlaku	97 dB(A)
Úroveň akustického výkonu	108 dB(A)
Hmotnosť	1,5 – 1,8 kg

LXT BL XPT MOTOR EXTREME PROTECTION TECHNOLOGY

DTW301RTJ  
539,99 €

DTW301Z  
259,99 €

## Aku rázový uťahovač

DTW700 1/2"

Li-ion



18V



Max. uťahovací výkon	Štandardná skrutka: M10 – M24 Vysokopevnostná skrutka: M10 – M16
Upínanie	1/2" (12,7 mm)
Voľnobežné otáčky / min <sup>-1</sup>	0 – 2.200 / 1.900 / 1.200 / 500
Počet úderov za minútu	0 – 2.700 / 2.400 / 1.700 / 1.000
Max. uťahovací moment	700 N·m
Vibrácie	19 m/s <sup>2</sup>
Úroveň akustického tlaku	94 dB(A)
Úroveň akustického výkonu	105 dB(A)
Hmotnosť	2,3 – 2,7 kg

LXT BL XPT MOTOR EXTREME PROTECTION TECHNOLOGY

DTW700RTJ  
616,99 €

DTW700Z  
324,99 €

## Aku rázový uťahovač

DTW251 1/2"

Li-ion



18V



Max. uťahovací výkon	Skrutka štandardná: M10 – M16 Skrutka vysokopevnostná: M10 – M14
Upínanie	1/2"
Voľnobežné otáčky / min <sup>-1</sup>	0 – 2.100
Počet úderov za minútu	0 – 3.200
Max. uťahovací moment	230 N·m
Vibrácie	11,0 m/s <sup>2</sup>
Úroveň akustického tlaku	94 dB(A)
Úroveň akustického výkonu	105 dB(A)
Rozmery	165×79×234 mm
Hmotnosť	1,5 – 1,8 kg

LXT

DTW251RTJ  
467,99 €

DTW251Z  
139,99 €



## Aku rázový uťahovač

DTW181 1/2"

Li-ion



18V



Max. uťahovací výkon	Skrutka štandardná: M8 – M16
	Skrutka vysokopevnosť: M6 – M12
Upínanie	1/2"
Voľnobežné otáčky / min <sup>-1</sup>	0 – 2.400
Počet úderov za minútu	0 – 3.600
Max. uťahovací moment	180 Nm
Hmotnosť	1,2 – 1,5 kg

**LXT BL XPT**  
 MOTOR EXTREME PROTECTION TECHNOLOGY

**DTW181RTJ**  
 486,99 €

**DTW181Z**  
 155,99 €

## Aku rázový uťahovač

DTW190 1/2"

Li-ion



18V



Max. uťahovací výkon	Skrutka štandardná: M8 – M16
	Skrutka vysokopevnosť: M8 – M12
Upínanie	1/2"
Voľnobežné otáčky / min <sup>-1</sup>	0 – 2.300
Počet úderov za minútu	0 – 3.000
Max. uťahovací moment	190 N·m
Vibrácie	8,5 m/s <sup>2</sup>
Úroveň akustického tlaku	94 dB(A)
Úroveň akustického výkonu	105 dB(A)
Rozmery	176 mm
Hmotnosť	1,4 – 1,8 kg

**LXT**
**DTW190JX3**  
 363,99 €

**DTW190RFJ**  
 368,99 €

**DTW190Z**  
 87,99 €

X3 – 9 ks sada nástrčkových kľúčov

## Aku uťahovač /račna/

DWR180

Li-ion



18V



Max. uťahovací výkon	Skrutka štandardná: M5 – M12
	Skrutka vysokopevnosť: M5 – M10
Upínanie	3/8" / 1/4"
Voľnobežné otáčky / min <sup>-1</sup>	0 – 800
Max. uťahovací moment	47,5 N·m
Hmotnosť	1,2 – 1,6 kg

**LXT XPT**  
 EXTREME PROTECTION TECHNOLOGY

**DWR180RA**  
 303,99 €

**DWR180Z**  
 162,99 €

## Aku viazač armatúr

DTR181

NOVINKA

Li-ion



18V

14.4V



Max. hrúbka viazacieho drôtu	0,8 mm
Max. hrúbka armatúr	D16×D16, (D13×2)×(D16×2)
Hmotnosť	2,3 – 2,6 kg

**LXT BL XPT**  
 MOTOR EXTREME PROTECTION TECHNOLOGY

**DTR181RTJ**  
 Cena na vyžiadanie

**DTR181ZJ**  
 Cena na vyžiadanie

## Aku viazač armatúr

DTR180

Li-ion



18V

14.4V



Max. hrúbka viazacieho drôtu	0,8 mm
Max. hrúbka armatúr	D10×D10 (D13×2)×(D13×2)
Vibrácie	2,5 m/s <sup>2</sup>
Úroveň akustického tlaku	78 dB (A)
Hmotnosť	2,3 – 2,6 kg

**LXT BL XPT**  
 MOTOR EXTREME PROTECTION TECHNOLOGY

**DTR180ZJ**  
 1 081,99 €

**Aku miešadlo**

**DUT130**

**Li-ion**



**18V**



Priemer miešacej metly	165 mm
Voľnobežné otáčky min <sup>-1</sup>	Max / Min: 0 – 1.300 / 0 – 350
Úroveň akustického tlaku	74 dB(A)
Rozmery	320×89×231 mm
Hmotnosť	2,5 – 2,8 kg

**LXT BL XPT**  
EXTREME PROTECTION TECHNOLOGY

**DUT130RTE**  
648,99 €

**DUT130Z**  
357,99 €

**Aku pumpa**

**DMP181**

**NOVINKA**

**Li-ion**



**18V**



Max. tlak vzduchu	1.110 kPa (161 PSI) [11,1 bar]
Dĺžka hadice	65 cm
Rozmery	297×108×231 mm
Hmotnosť	2,5 – 2,8 kg

**LXT XPT**  
EXTREME PROTECTION TECHNOLOGY

**DMP181Z**  
148,99 €

**Aku pumpa**

**DMP180**

**Li-ion**



**18V**



Max. tlak vzduchu	830 kPa (121 PSI) [8,3 bar]
Dĺžka hadice	65 cm
Rozmery	270×76×175 mm
Hmotnosť	1,5 – 1,8 kg

**LXT**

**DMP180Z**  
97,99 €

**Aku uhlová vrtáčka**

**DDA351 / DDA350 10 mm**

**Li-ion**



**18V**



Max. vrtací výkon	Železo: 10 mm Drevo: 25 mm
Voľnobežné otáčky / min <sup>-1</sup>	0 – 1.800
Rozmery	DDA351: 326×79×115 mm DDA350: 314×79×115 mm
Hmotnosť	DDA351: 1,6 – 1,9 kg DDA350: 1,5 – 1,8 kg

**LXT**

▲ DDA350

**DDA351Z**  
205,99 €

**DDA350Z**  
205,99 €

**Aku uhlový rázový skrutkovač**

**DTL063 3/8"**

**Li-ion**



**18V**



Max. ťahovací výkon	Skrutka štandardná: M4 – M12 Skrutka vysokopevnostná: M4 – M8
Upínanie	3/8"
Voľnobežné otáčky / min <sup>-1</sup>	0 – 2.000
Počet úderov za minútu	0 – 3.000
Max. ťahovací moment	60 N·m
Vibrácie	16,5 m/s <sup>2</sup>
Úroveň akustického tlaku	88 dB(A)
Úroveň akustického výkonu	99 dB(A)
Rozmery	387×78×116 mm
Hmotnosť	1,4 – 2,0 kg

**LXT**

**DTL063RTJ**  
623,99 €

## Aku skrutkovač

DFS452

Li-ion



18V

**LXT BL XPT**  
 MOTOR  
 EXTREME PROTECTION TECHNOLOGY

Max. vrtací výkon	Samozávrtné skrutky: 6 mm
	Skrutky na sadrokartón: 5 mm
Upínanie	1/4"
Voľnobežné otáčky / min <sup>-1</sup>	0 – 4.000
Vibrácie	2,5 m/s <sup>2</sup>
Úroveň akustického tlaku	72 dB(A)
Rozmery	251×79×259 mm
Hmotnosť	1,5 – 1,8 kg

**DFS452Z**  
 227,99 €

## Aku skrutkovač

DFS251

Li-ion



18V

**LXT BL XPT**  
 MOTOR  
 EXTREME PROTECTION TECHNOLOGY

Max. vrtací výkon	Samozávrtné skrutky: 6 mm
	Skrutky na sadrokartón: 5 mm
Upínanie	1/4"
Voľnobežné otáčky / min <sup>-1</sup>	0 – 2.500
Vibrácie	2,5 m/s <sup>2</sup>
Úroveň akustického tlaku	72 dB(A)
Rozmery	237×79×259 mm
Hmotnosť	1,5 – 1,8 kg

**DFS251RTJ**  
 529,99 €

**DFS251Z**  
 249,99 €

## Aku skrutkovač

DFR452

NOVINKA

Li-ion



18V

**LXT BL XPT**  
 MOTOR  
 EXTREME PROTECTION TECHNOLOGY

Veľkosť skrutiek na páse	4 × 20 – 41 mm
Upínanie	1/4"
Voľnobežné otáčky / min <sup>-1</sup>	0 – 6.000
Rozmery	360 × 88 × 165 - 211 mm
Hmotnosť	1,9 – 2,2 kg

**DFR452Z**  
 405,99 €

## Aku skrutkovač

DFR551

NOVINKA

Li-ion



18V

**LXT BL XPT**  
 MOTOR  
 EXTREME PROTECTION TECHNOLOGY

Veľkosť skrutiek na páse	4 × 25 – 55 mm
Upínanie	1/4"
Voľnobežné otáčky / min <sup>-1</sup>	0 – 6.000
Rozmery	396 × 88 × 165 - 211 mm
Hmotnosť	1,9 – 2,2 kg

**DFR551RTJ**  
 675,99 €

**DFR551Z**  
 415,99 €

## Aku skrutkovač

DFR550

Li-ion



18V

**LXT**

Veľkosť skrutiek na páse	4×25 – 55 mm
Upínanie	1/4"
Voľnobežné otáčky / min <sup>-1</sup>	4.000
Vibrácie	2,5 m/s <sup>2</sup>
Úroveň akustického tlaku	78 dB(A)
Rozmery	424×80×238 mm
Hmotnosť	2,1 – 3,1 kg

**DFR550RFE**  
 539,99 €

**DFR550Z**  
 324,99 €



## Aku SDS Plus kladivo

DHR243 1/2" (12,7 mm)

Li-ion

Rýchlosklučovadlo



DHR243

18V



W – s odsávacím zariadením

DHR243RTJW

**LXT BL XPT**  
MOTOR EXTREME PROTECTION TECHNOLOGY

Energia príklepu	2 J
Max. vrtací výkon	Betón: 24 mm
	Železo: 13 mm
	Drevo: 27 mm
Počet úderov za minútu	0 – 4.700
Voľnobežné otáčky / min <sup>-1</sup>	0 – 950
Úroveň akustického tlaku	89 dB(A)
Úroveň akustického výkonu	100 dB(A)
Vibrácie	Vrtanie s príklepom do betónu: 13 m/s <sup>2</sup>
	Sekanie: 11 m/s <sup>2</sup>
	Vrtanie: 2,5 m/s <sup>2</sup>
Rozmery	353×85×213mm
Hmotnosť	3,2 – 3,7 kg

DHR243RTJW  
675,99 €DHR243Z  
332,99 €

## Aku SDS Plus kladivo

DHR241 20 mm

Li-ion



18V

**LXT**

Energia príklepu	1,9 J
Max. vrtací výkon	Betón: 20 mm
	Železo: 13 mm
	Drevo: 26 mm
Počet úderov / min <sup>-1</sup>	0 – 4.000
Voľnobežné otáčky / min <sup>-1</sup>	0 – 1.100
Úroveň akustického tlaku	86 dB(A)
Úroveň akustického výkonu	97 dB(A)
Vibrácie	Vrtanie s príklepom do betónu: 12,5 m/s <sup>2</sup>
Rozmery	417×84×219 mm
Hmotnosť	3,2 – 4,0 kg

DHR241RTJ  
432,99 €DHR241Z  
195,99 €

## Aku SDS Plus kladivo

DHR202 20 mm

Li-ion



18V

**LXT**

Max. vrtací výkon	Betón: 20 mm
	Železo: 13 mm
	Drevo: 26 mm
Počet úderov / min <sup>-1</sup>	0 – 4.000
Voľnobežné otáčky / min <sup>-1</sup>	0 – 1.100
Rozmery	358×84×259 mm
Hmotnosť	3,2 – 4,0 kg

DHR202RTJ  
486,99 €DHR202Z  
205,99 €

## Aku SDS Plus kladivo

DHR182

Li-ion



18V

**AWS AVT**  
**LXT BL XPT**  
MOTOR EXTREME PROTECTION TECHNOLOGY

Energia príklepu	EPTA-Procedure 05/2009: 1,7 J
Max. vrtací výkon	Betón: 18 mm
	Železo: 13 mm
	Drevo: 24 mm
Počet úderov / min	0 – 5.000
Voľnobežné otáčky / min <sup>-1</sup>	0 – 1.350
Úroveň akustického tlaku	89 dB(A)
Úroveň akustického výkonu	100 dB(A)
Rozmery	301×82×285 mm
Hmotnosť	2,4 – 3,2 kg

DHR182RTJ  
539,99 €DHR182Z  
269,99 €

## Aku SDS Plus kladivo

DHR171 17 mm

Li-ion



18V

**LXT BL**  
MOTOR

Energia príklepu	EPTA-Procedure 05/2009: 1,2 J
Max. vrtací výkon	Betón: 17 mm
	Železo: 10 mm
	Drevo: 13 mm
Počet úderov / min <sup>-1</sup>	0 – 4.800
Voľnobežné otáčky / min <sup>-1</sup>	0 – 680
Vibrácie	Vrtanie s príklepom do betónu: 9,0 m/s <sup>2</sup>
	Vrtanie do železa: 2,5 m/s <sup>2</sup>
Úroveň akustického tlaku	86 dB(A)
Úroveň akustického výkonu	97 dB(A)
Rozmery	s BL1815N / BL1820B: 273×86×194 mm
	s BL1830B / BL1840B / BL1850B / BL1860B: 273×86×211 mm
Hmotnosť	2,1 – 2,8 kg

DHR171RTJ  
432,99 €DHR171Z  
207,99 €

## Aku SDS Plus sekacie kladivo

DHK180

Li-ion



18V



Energia príklepu	EPTA-Procedure 05/2009: 3,1 J
Počet úderov / min	0 – 3.200
Rozmery	368x99x211 mm
Hmotnosť	3,3 – 3,6 kg

**LXT**  
**BL MOTOR** **AVT** **XPT**  
EXTREME PROTECTION TECHNOLOGY

**DHK180ZJ**  
**648,99 €**

## Aku strihač závitových tyčí

DSC102

Li-ion



18V



Max. rezný výkon	Železo: M6 – M10 mm
Rozmery	199x103x308 mm
Hmotnosť	2,9 – 3,3 kg

**LXT**  
**BL MOTOR**

**DSC102Z**  
**648,99 €**

## Aku strihač roxorov

DSC163

Li-ion



18V



Max. výkon	Priemer: 3 – 16 mm
Rezná rýchlosť	2,8 sec
Rozmery	360x108x276 mm
Hmotnosť	6,9 kg

**LXT**

**DSC163ZK**  
**2 703,99 €**

## Aku píla na železo

DCS552

Li-ion



18V



Priemer kotúča	136 mm
Max. rezný výkon	90°: 50,5 mm
Voľnobežné otáčky / min <sup>-1</sup>	3.600
Vibrácie	2,5 m/s <sup>2</sup>
Úroveň akustického tlaku	102 dB (A)
Úroveň akustického výkonu	113 dB (A)
Rozmery	348x196x203 mm
Hmotnosť	2,4 – 2,7 kg

**LXT**

**DCS552RTJ**  
**519,99 €**

**DCS552Z**  
**205,99 €**

## Aku píla na železo

DCS553

Li-ion



18V



Priemer kotúča	150 mm
Max. rezný výkon	90°: 57,5 mm
Voľnobežné otáčky / min <sup>-1</sup>	4.200
Vibrácie	2,5 m/s <sup>2</sup>
Úroveň akustického tlaku	103 dB (A)
Úroveň akustického výkonu	114 dB (A)
Rozmery	267x186x250 mm
Hmotnosť	2,8 – 3,1 kg

**BRAKE** **LXT**  
**BL MOTOR** **ADT** **XPT**  
EXTREME PROTECTION TECHNOLOGY

**DCS553RTJ**  
**648,99 €**

**DCS553Z**  
**346,99 €**

**Aku diamantová rezačka**

DCC500

**NOVINKA**

**Li-ion**



18V



Priemer kotúča	125 mm
Víťanie kotúča	20 mm
Max. rezný výkon	90°: 40,0 mm
	45°: 27 mm
Voľnobežné otáčky / min <sup>-1</sup>	8.800
Vibrácie	4,0 m/s <sup>2</sup>
Úroveň akustického tlaku	96 dB(A)
Úroveň akustického výkonu	107 dB(A)
Rozmery	283×158×172 mm
Hmotnosť	2,6 – 3,1 kg

Pripojenie na lištu s adaptérom 198673-2

**LXT AWS**  
**BL MOTOR** **ADT** **XPT**  
EXTREME PROTECTION TECHNOLOGY

**DCC500RTE**  
**508,99 €**

**DCC500Z**  
**216,99 €**

**Aku rezač roxorov**

DSC251

**Li-ion**



18V



Priemer kotúča	110 mm
Max. rezný výkon	priemer 10 – 25 mm
Voľnobežné otáčky / min <sup>-1</sup>	2.200
Vibrácie	Rezanie železa: 2,5 m/s <sup>2</sup>
Úroveň akustického tlaku	78 dB(A)
Rozmery	471×137×139 mm
Hmotnosť	4,0 kg

**LXT**  
**BL MOTOR** **ADT** **LXT**

**DSC251ZK**  
**1 351,99 €**

**Aku prestrihovač**

DJN161 1,6 mm (16 Ga)

**Li-ion**



18V



Max. výkon	Železo do 400 N/mm <sup>2</sup> : 1,6 mm
	Železo do 600 N/mm <sup>2</sup> : 1,2 mm
	Hliník do 200 N/mm <sup>2</sup> : 2,5 mm
Min. rádius	Vnútorný oblúk: 45 mm
	Vonkajší oblúk: 50 mm
Počet strihov za minútu	1.900
Rozmery	313×78×189 mm
Hmotnosť	1,9 – 2,3 kg

**LXT**

**DJN161RFJ**  
**703,99 €**

**DJN161Z**  
**432,99 €**

**Aku nožnice na plech**

DJS131

**NOVINKA**

**Li-ion**



18V



Max. strihací výkon	železo: 1,3 mm
	nerez: 1,0 mm
Počet strihov za minútu	0 – 3.000
Rozmery	332×79×234 mm
Hmotnosť	2,0 – 2,3 kg

**LXT** **BL MOTOR** **XPT**  
EXTREME PROTECTION TECHNOLOGY

**DJS131Z**  
**519,99 €**

**Aku nožnice na plech**

DJS200

**NOVINKA**

**Li-ion**



18V



Max. strihací výkon	železo: 2,0 mm
	nerez: 1,6 mm
Počet strihov za minútu	0 – 3.000
Rozmery	345×79×189 mm
Hmotnosť	2,2 – 2,5 kg

**LXT** **BL MOTOR** **XPT**  
EXTREME PROTECTION TECHNOLOGY

**DJS200Z**  
**486,99 €**



## Aku nožnice na cementové dosky DJS800

NOVINKA

Li-ion



18V

**LXT BL XPT**  
 MOTOR EXTREME PROTECTION TECHNOLOGY

Max. strihací výkon	13 mm
Počet strihov za minútu	0 – 3.000
Rozmery	379x79x198 mm
Hmotnosť	2,1 – 2,5 kg

**DJS800Z**  
**519,99 €**

## Aku uhlová brúska DGA521

NOVINKA

Li-ion



18V

**LXT XPT ADT**  
 MOTOR EXTREME PROTECTION TECHNOLOGY  
**AFT BL XLOCK**

Priemer kotúča	125 mm
Max. hrúbka kotúča	6 mm
Voľnobežné otáčky / min <sup>-1</sup>	8.500
Rozmery	361x140x146 mm
Hmotnosť	2,4 – 3,0 kg

**DGA521ZX1**  
**227,99 €**

## Aku uhlová brúska DGA519 125 mm

DGA519 125 mm

Li-ion



18V

**(BRAKE) XPT**  
 MOTOR EXTREME PROTECTION TECHNOLOGY  
**LXT BL XLOCK**

Priemer kotúča	125 mm
Voľnobežné otáčky / min <sup>-1</sup>	3.000 – 8.500
Rozmery	396x117x147 mm
Hmotnosť	2,4 – 3,0 kg

**DGA519Z**  
**301,99 €**

## Aku uhlová brúska DGA513 125 mm

DGA513 125 mm

Li-ion



18V

**LXT BL ADT**  
 MOTOR  
**AFT XPT (BRAKE)**

Priemer kotúča	125 mm
Voľnobežné otáčky / min <sup>-1</sup>	3.000 – 8.500
Úroveň akustického tlaku	79 dB(A)
Rozmery	s BL1815N / BL1820B: 368x140x151 mm s BL1830B / BL1840B / BL1850B / BL1860B: 382x140x151 mm
Hmotnosť	2,4 – 3,0 kg

**DGA513RTJ**  
**498,99 €**
**DGA513ZJ**  
**238,99 €**

## Aku uhlová brúska DGA511 125 mm

DGA511 125 mm

Li-ion



18V

**BL ADT**  
 MOTOR  
**LXT AFT XPT**  
 EXTREME PROTECTION TECHNOLOGY

Priemer kotúča	125 mm
Voľnobežné otáčky / min <sup>-1</sup>	3.000 – 8.500
Úroveň akustického tlaku	79 dB(A)
Rozmery	s BL1815N / BL1820B: 368x140x145 mm s BL1830B / BL1840B / BL1850B / BL1860B: 382x140x145 mm
Hmotnosť	2,3 – 3,0 kg

**DGA511RFJ**  
**378,99 €**
**DGA511Z**  
**207,99 €**

**Aku uhlová brúska**

**DGA506** 125 mm

**Li-ion**



**LXT BL ADT**  
**AFT XPT** (BRAKE)

18V



Priemer kotúča	125 mm
Voľnobežné otáčky / min <sup>-1</sup>	8.500
Úroveň akustického tlaku	79 dB(A)
Rozmery	362×140×151 mm
Hmotnosť	2,35 – 3,83 kg

**DGA506RTJ**  
508,99 €

**DGA506ZJ**  
216,99 €

**Aku uhlová brúska**

**DGA504** 125 mm

**Li-ion**



**BL ADT**  
**LXT AFT XPT**

18V



Priemer kotúča	125 mm
Voľnobežné otáčky / min <sup>-1</sup>	8.500
Úroveň akustického tlaku	79 dB(A)
Rozmery	362×140×145 mm
Hmotnosť	2,26 – 3,73 kg

**DGA504RTJ**  
478,99 €

**DGA504ZJ**  
216,99 €

**Aku uhlová brúska**

**DGA452** 115 mm

**Li-ion**



**LXT**

18V



Priemer kotúča	115 mm
Voľnobežné otáčky / min <sup>-1</sup>	11.000
Úroveň akustického tlaku	76 dB(A)
Rozmery	317×129×126 mm
Hmotnosť	2,06 – 2,71 kg

**DGA452RTJ**  
389,99 €

**DGA452Z**  
108,99 €

**Aku uhlová brúska**

**DGA518** 125 mm

**Li-ion**



**BL ADT AWS**  
**LXT AFT XPT** (BRAKE)

18V



Priemer kotúča	125 mm
Voľnobežné otáčky / min <sup>-1</sup>	3.000 – 8.500
Úroveň akustického tlaku	79 dB(A)
Rozmery	s BL1815N / BL1820B: 368×140×151 mm s BL1830B / BL1840B / BL1850B / BL1860B: 382×140×151 mm
Hmotnosť	2,4 – 3,1 kg

**DGA518ZJU**  
324,99 €

**Aku brúska na sadrokartón**

**DSL801**

**NOVINKA**

**Li-ion**



**LXT BL**  
**XPT AWS**

18V



Priemer padu	210 mm
Priemer brúsnych kotúčov	225 mm
Voľnobežné otáčky / min <sup>-1</sup>	1.000 – 1.800
Vibrácie	2,5 m/s <sup>2</sup>
Úroveň akustického tlaku	75 dB(A)
Rozmery	1.120 – 1.540×278×273 mm
Hmotnosť	4,6 – 5,8 kg

**DSL801RTEU**  
935,99 €

**DSL801ZU**  
669,99 €

## Aku priama brúska

DGD800

Li-ion



18V



Upínanie	Klieština: 3 – 8 mm
Priemer kotúča	38 mm
Voľnobežné otáčky / min <sup>-1</sup>	26.000
Rozmery	402×82×118 mm
Hmotnosť	1,7 – 2,2 kg

LXT

DGD800RTJ  
519,99 €DGD800Z  
176,99 €

## Aku excentrická brúska

DBO180 125 mm

Li-ion



18V



Priemer základnej dosky	123 mm
Priemer brúsnej plochy	125 mm
Excentrický výkyv za minútu	7.000/ 9.500/ 11.000
Rozmery	175×123×153 mm
Hmotnosť	1,4 – 1,7 kg

LXT

DBO180Z  
162,99 €

## Aku excentrická brúska

DBO380 / DB0381

NOVINKA

Li-ion



18V



Veľkosť padu	93×185 mm
Priemer brúsnych papierov	93×228 mm
Excentrický výkyv za minútu	4.000 / 8.000 / 12.000
Počet kmitov za minútu	8.000 / 16.000 / 24.000
Priemer výkyvu	ø 2,0 mm
Vibrácie	3,6 m/s <sup>2</sup>
Úroveň akustického tlaku	72 dB(A)
Rozmery	336×93×158 mm
Hmotnosť	1,9 – 2,2 kg

LXT

BL MOTOR XPT AWS

▲ DB0381

DBO380RTJ  
426,99 €DBO380Z  
145,99 €DBO381ZU  
239,99 €

## Aku úhlová vrtáčka

DDA450

NOVINKA

Li-ion



18V



Max. vrtací výkon	železo 13 mm, drevo (vrták 65 mm / korunka 127 mm)
Voľnobežné otáčky	Max: 0 – 1.400 min <sup>-1</sup> Min: 0 – 450 min <sup>-1</sup>
Max. ťahovací moment	Max: 70 Nm Min: 26 Nm
Vibrácie	vrtanie do železa 2,5 m/s <sup>2</sup>
Úroveň akustického tlaku	83 dB(A)
Úroveň akustického výkonu	94 dB(A)
Rozmery	434×82×179 mm
Hmotnosť	3,2 – 3,5 kg

BL MOTOR XPT LXT

DDA450RTE  
592,99 €DDA450ZK  
378,99 €



**Aku excentrická brúska**

DBO480

**NOVINKA**

**Li-ion**



18V



Veľkosť padu	112 x 102 mm
Priemer brúsnych papierov	114 x 102 mm
	pravouhly: 114 x 190 mm
	trojuholníkový: 96 x 96 mm
Počet kmitov za minútu	14.000
Rozmery	156 x 112 x 151 mm
Hmotnosť	1,7 kg

**LXT**

**DBO480RTJ**  
Cena na vyžiadanie

**DBO480Z**  
Cena na vyžiadanie

**Aku pásová brúska**

DBS180

**Li-ion**



18V



Šírka brúsneho pásu	6 / 9 / 13 mm
Dĺžka brúsneho pásu	533 mm
Rýchlosť brúsneho pásu	600 – 1,700 m/min
Vibrácie	2,5 m/s <sup>2</sup> or less
Úroveň akustického tlaku	77 dB(A)
Hmotnosť	1,8 – 2,1 kg

**LXT BL MOTOR**

**DBS180Z**  
324,99 €

**Aku multifunkčné náradie**

DTM52

**NOVINKA**

**Li-ion**



18V



Počet kmitov za minútu	10.000 – 20.000
Uhol kmitu	Ľavý / Pravý / Spolu: 1,8° / 1,8° / 3,6°
Rozmery	305x95x125 mm
Hmotnosť	1,7 – 2,0 kg

**LXT BL MOTOR XPT AVT**

**DTM52RFJX1**  
509,99 €

**DTM52Z**  
216,99 €

**Aku multifunkčné náradie**

DTM51

**Li-ion**



18V



Počet kmitov za minútu	6.000 – 20.000
Uhol kmitu	Ľavý / Pravý / Spolu: 1,6° / 1,6° / 3,2°
Rozmery	340x80x122 mm
Hmotnosť	2,0 – 2,4 kg

**LXT**

X1 – extra príslušenstvo

**DTM51RFJX1**  
454,99 €

**DTM51Z**  
187,99 €

**Aku kotúčová píla**

DHS660 165 mm

**Li-ion**



18V



Priemer kotúča	165 mm
Vrtanie kotúča	20 mm
Max. rezný výkon	90°: 57 mm, 45°: 41 mm, 50°: 37 mm
Voľnobežné otáčky / min <sup>-1</sup>	5.000
Úroveň akustického tlaku	93 dB(A)
Úroveň akustického výkonu	104 dB(A)
Vibrácie	2,5 m/s <sup>2</sup>
Rozmery	270x186x250 mm
Hmotnosť	2,9 – 3,2 kg

Pripojenie na lištu s adaptérom 199232-5

**LXT (BRAKE) BL MOTOR ADT XPT**

**DHS660RTJ**  
592,99 €

**DHS660ZJ**  
291,99 €

## Aku kotúčová píla

DHS661 165 mm

Li-ion



Priemer kotúča	165 mm
Víťanie kotúča	20 mm
Max. rezný výkon	90°: 57 mm, 45°: 41 mm, 50°: 37 mm
Voľnobežné otáčky / min <sup>-1</sup>	5.000
Úroveň akustického tlaku	93 dB(A)
Úroveň akustického výkonu	104 dB(A)
Vibrácie	2,5 m/s <sup>2</sup>
Rozmery	270x186x250 mm
Hmotnosť	2,9 – 3,2 kg

18V



LXT (BRAKE) AWS  
BL ADT XPT  
MOTOR EXTREME PROTECTION TECHNOLOGY

DHS661RTJU  
703,99 €DHS661ZJU  
411,99 €

## Aku kotúčová píla

DHS680 165 mm

Li-ion



Priemer kotúča	165 mm
Max. rezný výkon	90°: 57 mm 45°: 41 mm 50°: 37 mm
Voľnobežné otáčky / min <sup>-1</sup>	5.000
Vibrácie	Pri rezaní dreva: 2,5 m/s <sup>2</sup>
Úroveň akustického tlaku	83 dB(A)
Úroveň akustického výkonu	94 dB(A)
Rozmery	350x170x238 mm
Hmotnosť	3,0 – 3,3 kg

18V



LXT BL ADT  
MOTOR

DHS680RTJ  
648,99 €DHS680Z  
279,99 €

Pripojenie na lištu s adaptérom 196953-0

## Aku kotúčová píla

DSS610 165 mm

Li-ion



Priemer kotúča	165 mm
Max. rezný výkon	90°: 0 – 57 mm 45°: 0 – 40 mm 50°: 0 – 36 mm
Voľnobežné otáčky / min <sup>-1</sup>	3.700
Rozmery	347x202x228 mm
Hmotnosť	3,0 – 3,4 kg

18V



LXT

DSS610Z  
197,99 €

Pripojenie na lištu nie

## Aku priamočiara píla

DJV184

NOVINKA

Li-ion



Max. rezný výkon	Drevo: 135 mm Železo: 10 mm Hliník: 20 mm
Dĺžka kmitu	23 mm
Počet kmitov za minútu	0 – 3.000
Rozmery	259 x 78 x 205 mm
Hmotnosť	2,1 – 2,5 kg

18V



SOFT NO LOAD  
LXT BL XPT  
MOTOR EXTREME PROTECTION TECHNOLOGY

DJV184RTJ  
Cena na vyžiadanieDJV184Z  
Cena na vyžiadanie

## Aku priamočiara píla

DJV182

Li-ion



Max. rezný výkon	Drevo: 135 mm Železo: 10 mm
Dĺžka kmitu	26 mm
Počet kmitov za minútu	800 – 3.500
Rozmery	266x77x208 mm
Hmotnosť	2,4 – 2,7 kg

18V



LXT BL  
MOTOR

DJV182Z  
303,99 €

### Aku priamočiara píla

DJV181

Li-ion



18V



LXT BL MOTOR

Max. rezný výkon	Drevo: 135 mm
	Železo: 10 mm
Dĺžka kmitu	26 mm
Počet kmitov za minútu	800 – 3.500
Rozmery	298×77×189 mm
Hmotnosť	2,3 – 2,6 kg

DJV181RTJ  
574,99 €

DJV181Z  
269,99 €

### Aku priamočiara píla

DJV180

Li-ion



18V



LXT

Max. rezný výkon	Drevo: 135 mm
	Železo: 10 mm
Dĺžka kmitu	26 mm
Počet kmitov za minútu	0 – 2.600
Rozmery	257×73×208 mm
Hmotnosť	2,7 – 3,0 kg

DJV180Z  
249,99 €

### Aku chvostová píla

DJR187

Li-ion

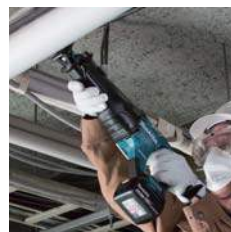

18V



LXT BL XPT MOTOR EXTREME PROTECTION TECHNOLOGY

Dĺžka kmitu	32 mm
Počet kmitov za minútu	Max / Min: 0 – 3.000 / 0 – 2.300
Max. rezný výkon	Rúra: 130 mm
	Drevo: 255 mm
Vibrácie	Drevené platne: 16,5 m/s <sup>2</sup>
	Drevené hrady: 15,5 m/s <sup>2</sup>
Úroveň akustického tlaku	84 dB(A)
Úroveň akustického výkonu	95 dB(A)
Rozmery	439×83×231 mm
Hmotnosť	3,4 – 3,8 kg

DJR187RTE  
539,99 €

DJR187Z  
259,99 €

### Aku chvostová píla

DJR186

Li-ion



18V



LXT XPT EXTREME PROTECTION TECHNOLOGY

Dĺžka kmitu	32 mm
Počet kmitov za minútu	0 – 2.800
Max. rezný výkon	Rúra: 130 mm
	Drevo: 255 mm
Vibrácie	Drevené platne: 13,0 m/s <sup>2</sup>
	Drevené hrady: 12,5 m/s <sup>2</sup>
Úroveň akustického tlaku	84 dB(A)
Úroveň akustického výkonu	95 dB(A)
Rozmery	486×81×223 mm
Hmotnosť	3,5 – 3,8 kg

DJR186RTE  
488,99 €

DJR186Z  
176,99 €

### Aku chvostová píla

DJR183

Li-ion



18V



LXT

Max. rezný výkon	Rúra: 50 mm
	Drevo: 50 mm
Dĺžka kmitu	13 mm
Počet kmitov za minútu	0 – 3.000
Rozmery	392×81×209 mm
Hmotnosť	1,5 – 1,7 kg

DJR183RTJ  
378,99 €

DJR183Z  
129,99 €



## Aku chvostová píla

DJR188

Li-ion



18V

**LXT BL XPT**  
 MOTOR EXTREME PROTECTION TECHNOLOGY

Dĺžka kmitu	20 mm
Počet kmitov za minútu	0 – 3.000
Max. rezný výkon	Rúra: 130 mm Drevo: 255 mm
Vibrácie	Drevené platne: 15,5 m/s <sup>2</sup> Drevené hrady: 15,0 m/s <sup>2</sup>
Úroveň akustického tlaku	83 dB(A)
Úroveň akustického výkonu	94 dB(A)
Rozmery	s BL1815N / BL1820B: 316×81×203 mm s BL1830B / BL1840B / BL1850B / BL1860B: 316×81×220 mm
Hmotnosť	2,6 – 2,9 kg

**DJR188RTJ**  
 476,99 €

**DJR188Z**  
 207,99 €

## Aku píla na sadrokartón a OSB

DSD180

Li-ion



18V

**LXT**

Počet kmitov za minútu	0 – 6.000
Dĺžka kmitu	6 mm
Max. rezný výkon	Sadrokartón: 30 mm Drevo: 15 mm
Vibrácie	Rezanie sadrokartónu (hrúbka 30 mm): 2,5 m/s <sup>2</sup> Rezanie OSB (hrúbka 15 mm): 5,0 m/s <sup>2</sup>
Úroveň akustického tlaku	79 dB(A)
Rozmery	263×79×291 mm
Hmotnosť	1,7 – 2,0 kg

**DSD180Z**  
 291,99 €

## Aku hoblík

DKP181

Li-ion



18V

**ADT**  
**LXT BL AWS**  
 MOTOR  
 ĎKP181ZU

Šírka záberu	82 mm
Hĺbka hobl'ovania	3 mm
Volnobežné otáčky / min <sup>-1</sup>	12.000
Rozmery	366×156×166 mm
Hmotnosť	3,3 – 3,6 kg

**DKP181Z**  
 303,99 €

**DKP181ZU**  
 378,99 €

## Aku hoblík

DKP180 82 mm

Li-ion



18V

**LXT**

Šírka záberu	82 mm
Hĺbka hobl'ovania	2,0 mm
Volnobežné otáčky / min <sup>-1</sup>	14.000
Rozmery	333×157×160 mm
Hmotnosť	3,2 – 3,5 kg

**DKP180RTJ**  
 539,99 €

**DKP180Z**  
 216,99 €

## Aku nitovačka

DRV250

Li-ion



18V

**LXT BL XPT**  
 MOTOR EXTREME PROTECTION TECHNOLOGY

Ťažná sila	20 kN
Zdvih	30 mm
Veľkosť nitov	2,4 – 6,4 mm
Úroveň akustického tlaku	74 dB(A)
Rozmery	323×80×287 mm
Hmotnosť	2,1 – 2,4 kg

**DRV250RFJ**  
 1 089,99 €

**DRV250ZJ**  
 865,99 €

## Aku nitovačka

DRV150

Li-ion



Ťažná sila	10 kN
Zdvih	25 mm
Veľkosť nitov	2,4 – 4,8 mm
Úroveň akustického tlaku	75 dB(A)
Rozmery	313×80×287 mm
Hmotnosť	1,9 – 2,2 kg

18V



**LXT** **BL** **XPT**  
MOTOR  
SERVO PROTECTION TECHNOLOGY

DRV150RFJ  
1 089,99 €

DRV150ZJ  
865,99 €

## Aku pásová píla

DPB182

Li-ion



Max. rezný výkon	64 mm
Rychlosť noža	3,2 m/s
Veľkosť noža	dĺžka: 835 mm
	šírka: 13 mm
	hrúbka: 0,5 mm
Vibrácie	rezníe železa 2,5 m/s <sup>2</sup>
Úroveň akustického tlaku	79 dB(A)
Rozmery	477×197×229 mm
Hmotnosť	3,8 – 4,1 kg

18V



**LXT**

DPB182Z  
269,99 €

## Aku pásová píla

DPB183

Li-ion



Max. rezný výkon	66 mm
Rychlosť noža	3,2 m/s
Veľkosť noža	dĺžka: 835 mm
	šírka: 13 mm
	hrúbka: 0,5 mm
Vibrácie	rezníe železa 2,5 m/s <sup>2</sup>
Úroveň akustického tlaku	80 dB(A)
Hmotnosť	3,6 – 3,9 kg

18V



**LXT** **BL**  
MOTOR

DPB183Z  
399,99 €

## Aku teplovzdušná pištoľ

DHG180

NOVINKA

Li-ion



Teplota vzduchu	550 °C
Max. prietok vzduchu	250 L/min
Pracovný čas cca.	Max / Min: 30 / 21 min / BL1860B
Rozmery	168×79×251 mm
Hmotnosť	0,97 – 1,3 kg
Displej	nie

18V



**LXT**

DHG180ZK  
156,99 €

## Aku teplovzdušná pištoľ

DHG181

NOVINKA

Li-ion



Teplota vzduchu	550 °C
Max. prietok vzduchu	1: 120 L/min
	2: 200 L/min
Pracovný čas cca.	21 min / BL1860B
Rozmery	173×79×255 mm
Hmotnosť	0,99 – 1,3 kg
Displej	nie

18V



**LXT**

DHG181RT  
332,99 €

DHG181ZK  
164,99 €

## Aku mazací lis

DGP180

Li-ion



Počet zdvihov / min	430
Max. tlak	69 MPa
Kapacita zásobníka	475 ml
Dĺžka hadice	1,2 m
Rozmery	390x100x240 mm
Hmotnosť	4,2 – 6,0 kg

18V



LXT

DGP180Z  
324,99 €

## Aku leštička

DPO600

Li-ion



Rozmer padu	150 mm
Excentrický výkyv za minútu	Leštiaci mód: 0 – 6.800 Dolešťovací mód: 0 – 5.200
Počet strihov za minútu	Leštiaci mód: 0 – 13.600 Dolešťovací mód: 0 – 10.400
Voľnobežné otáčky	Leštiaci mód: 0 – 780 Dolešťovací mód: 0 – 600
Priemer výkyvu	5,5 mm
Vibrácie	10,0 m/s <sup>2</sup>
Úroveň akustického tlaku	83 dB(A)
Úroveň akustického výkonu	94 dB(A)
Rozmery	530x148x126 mm
Hmotnosť	3,1 – 3,6 kg

18V

LXT BL MOTOR XPT  
EXTREME PROTECTION TECHNOLOGYDPO600RTE  
648,99 €DPO600Z  
378,99 €

## Aku leštička

DPO500

Li-ion



Rozmer padu	125 mm
Excentrický výkyv za minútu	Leštiaci mód: 0 – 6.800 Dolešťovací mód: 0 – 5.200
Počet strihov za minútu	Leštiaci mód: 0 – 13.600 Dolešťovací mód: 0 – 10.400
Voľnobežné otáčky	Leštiaci mód: 0 – 780 Dolešťovací mód: 0 – 600
Priemer výkyvu	5,5 mm
Vibrácie	9,5 m/s <sup>2</sup>
Úroveň akustického tlaku	82 dB(A)
Úroveň akustického výkonu	93 dB(A)
Rozmery	530x123x134 mm
Hmotnosť	3,1 – 3,6 kg

18V

LXT BL MOTOR XPT  
EXTREME PROTECTION TECHNOLOGYDPO500Z  
454,99 €

## Aku leštička

DPV300

Li-ion



Priemer brúsneho kotúča	Leštenie: 80 mm Brúsenie: 50 mm
Voľnobežné otáčky	Leštenie: 0 – 2.800 Brúsenie: 0 – 9.500
Rozmery	160x79x256 mm
Hmotnosť	1,3 – 1,6 kg

18V

LXT BL MOTOR XPT  
EXTREME PROTECTION TECHNOLOGYDPV300RTJ  
561,99 €DPV300Z  
303,99 €

## Aku dierovač

DPP200

Li-ion



Max. hĺbka	Železo: 20 mm Nerez: 20 mm
Max. hĺbka hrdla	40 mm
Hmotnosť	10,5 kg

18V

LXT

DPP200ZK  
2 807,99 €



## Aku štrbinová fréza

DPJ180

Li-ion



18V



Priemer kotúča	100 mm
Max. hĺbka rezu	20 mm
Voľnobežné otáčky / min <sup>-1</sup>	6.500
Rozmery	351×139×149 mm
Hmotnosť	2,8 – 3,1 kg

LXT

DPJ180Z  
291,99 €

## Aku multifunkčná fréza

DRT50 8 mm

Li-ion



18V



Voľnobežné otáčky / min <sup>-1</sup>	10.000 – 30.000
Max. ponor	S orezávacou základňou: 0 – 40 mm So zanorovacou základňou: 0 – 35 mm
Vibrácie	Bez zaťaženia: 2,5 m/s <sup>2</sup> Pri rezaní drážky v MDF: 4,5 m/s <sup>2</sup>
Úroveň akustického tlaku	78 dB(A)
Rozmery	s BL1815N / BL1820B: 134×89×208 mm s BL1830B / BL1840B / BL1850B / BL1860B: 134×89×226 mm
Hmotnosť	1,8 – 2,1 kg

BL MOTOR LXT

X2 – ponorný nadstavec, frézovací nadstavec;  
X4 – vodítko, vedenie šablóny, doraz

DRT50RTJX2  
648,99 €

DRT50ZJX2  
363,99 €

DRT50ZX4  
216,99 €

## Aku rotačná frézka

DCO181

Li-ion



18V



Upínacia klieština	3,18 / 6,35 mm
Voľnobežné otáčky	32 000
Obvod úchopovej časti	210 mm (8 – 1/4")
Vibrácie	2,5 m/s <sup>2</sup>
Úroveň akustického tlaku	78 dB(A)
Hmotnosť	1,4 – 1,7 kg

LXT  
AWS BL MOTOR XPT  
EXTREME PROTECTION TECHNOLOGY

DCO181Z  
279,99 €

## Aku vákuová pumpa

DVP180

Li-ion 6.0 5.0 4.0 3.0



18V



Max prietok	50 L/min
Pracovný tlak	20 Pa (150 microns)
Rýchlosť motora	3.840 min <sup>-1</sup>
Objem olejovej nádoby	115 mL
Upínanie	5/16"
Rozmery	265×93×175 mm
Hmotnosť	3,5 kg

LXT

DVP180Z  
399,99 €

## Aku fukár

DUB185

Li-ion



18V



Max. prietok vzduchu	3,2 m <sup>3</sup> /min
Rýchlosť vzduchu	98 m/s
Tlak vzduchu	5,8 kPa
Voľnobežné otáčky / min <sup>-1</sup>	0 – 18.000
Úroveň akustického tlaku	83 dB(A)
Úroveň akustického výkonu	94 dB(A)
Vibrácie	2,5 m/s <sup>2</sup>
Hmotnosť	1,6 – 2,1 kg

LXT

DUB185Z  
64,99 €

## Aku fukár

DUB186

Li-ion



Max. prietok vzduchu	3,2 m³/min
Rýchlosť vzduchu	68 m/s
Voľnobežné otáčky / min⁻¹	0 – 18.000
Úroveň akustického tlaku	82,5 dB(A)
Úroveň akustického výkonu	92,4 dB(A)
Vibrácie	2,5 m/s²
Hmotnosť	1,6 – 2,1 kg

18V



LXT

DUB186Z  
78,99 €

## Aku zhutňovač

DVR450 1.200 mm

Li-ion



Priemer zhutňovača	25mm
Dĺžka hadice	1.200mm
Vibrácie / min/	13.000
Rozmery	1.483x93x250mm
Hmotnosť	3,3 – 3,8 kg

18V

LXT

DVR450RTE  
727,99 €DVR450Z  
399,99 €

## Aku pištoľ na silikón

DCG180

Li-ion



Max. tlak	5.000 N
Voľnobežné otáčky / min⁻¹	0 – 28 mm/sec. (0 – 66 in/min.)
Veľkosť nastavčov	300, 600, 800 mL
Úroveň akustického tlaku	70 dB(A)
Vibrácie	Bez zaťaženia: 2,5 m/s²
Rozmery	404x108x281 mm
Hmotnosť	2,1 – 3,0 kg

18V



LXT

DCG180RF  
432,99 €DCG180Z  
238,99 €

## Aku klincovačka

DFN350

Li-ion



Dĺžka klincov	15 – 35 mm
Kapacita zásobníka	110
Vibrácie	2,5 m/s²
Úroveň akustického tlaku	81 dB(A)
Úroveň akustického výkonu	92 dB(A)
Rozmery	257x79x228 mm
Hmotnosť	2,1 – 2,4 kg

18V

LXT XPT  
EXTREME PROTECTION TECHNOLOGYDFN350RFJ  
703,99 €DFN350Z  
454,99 €

## Aku klinovačka

DPT353

Li-ion



Dĺžka klincov	Dĺžka: 15, 18, 25, 30, 35 mm
	Priemer: 0,6 mm
	Kaliber: 23 Ga
Kapacita zásobníka	120
Vibrácie	2,5 m/s²
Úroveň akustického tlaku	76 dB(A)
Rozmery	257x79x226 mm
Hmotnosť	2,0 – 2,3 kg

18V



LXT

DPT353RFJ  
669,99 €DPT353Z  
411,99 €

## Aku sponkovačka

DST221

Li-ion



18V



Spunky	Šírka: 10 mm
	Dĺžka: 10, 13, 16, 19, 22 mm
	Kaliber: 0,6x1,2 mm
Kapacita zásobníka	98
Vibrácie	3,5 m/s <sup>2</sup>
Úroveň akustického tlaku	82 dB(A)
Úroveň akustického výkonu	93 dB(A)
Rozmery	251x91x212 mm
Hmotnosť	2,1 – 2,4 kg

LXT

DST221Z  
324,99 €

## Aku detektor

DWD181

Li-ion



18V



Max. hĺbka skenovania	Železo: 180 mm
	Živicová trubica: 120 mm
	El. drôt: 120 mm
	Drevo: 25 mm
Presnosť skenovania	+/-5 mm
Min. vzdialenosť skenovaných predmetov	40 mm
Hmotnosť	1,3 – 1,7 kg

LXT XPT  
EXTREME PROTECTION TECHNOLOGY

DWD181ZJ  
1 559,99 €

## Aku píla

DUC254 250 mm

Li-ion



18V



Dĺžka lišty	250 mm
Delenie reťaze	3/8"
Šírka drážky	1,1 mm
Rýchlosť reťaze	0 – 24 m/s (0 – 1.440 m/min)
Nádž na olej	140 mL
Úroveň akustického tlaku	92,2 dB(A)
Úroveň akustického výkonu	103,2 dB(A)
Vibrácie pri rezaní dreva:	3,1 m/s <sup>2</sup>
Hmotnosť	2,8 – 3,2 kg

LXT BL MOTOR XPT  
EXTREME PROTECTION TECHNOLOGY

DUC254Z  
249,99 €

## Aku plotostrih

DUH502

NOVINKA

Li-ion



18V



Dĺžka noža	500 mm
Počet strihov za minútu	Max / Priemer / Min: 0 – 4.400 / 0 – 3.600 / 0 – 2.000
Max. strihací výkon	21,5 mm
Úroveň akustického tlaku	81,3 dB(A)
Úroveň akustického výkonu	86,8 dB(A)
Vibrácie	2,5 m/s <sup>2</sup>
Rozmery	1.016x225x192 mm
Hmotnosť	3,7 – 4,4 kg

BL MOTOR XPT  
EXTREME PROTECTION TECHNOLOGY

DUH502RT  
447,99 €

DUH502Z  
299,99 €

## Aku plotostrih

DUH523 520 mm

Li-ion



18V



Dĺžka noža	520 mm
Počet strihov za minútu	2.700
Rozstup nožov	26 mm
Úroveň akustického tlaku	77 dB(A)
Úroveň akustického výkonu	84,3 dB(A)
Vibrácie	2,5 m/s <sup>2</sup>
Rozmery	938x195x193 mm
Max. výkon	210 W
Hmotnosť	3,0 – 3,4 kg

LXT

DUH523Z  
114,99 €



## Aku plotostrih

DUH601 600 mm

Li-ion



18V

**LXT BL XPT**  
 MOTOR EXTREME PROTECTION TECHNOLOGY

Dĺžka noža	600 mm
Max. rezný výkon	23,5 mm
Počet strihov/min	Max/priemer/min
	0 - 4.400 / 0 - 3.600 / 0 - 2.000
Rozmery	1.121×192×225 mm
Hmotnosť	4,0 - 4,3 kg

**DUH601PTE**  
 655,99 €

**DUH601Z**  
 343,99 €

## Aku plotostrih

DUH602 600 mm

Li-ion



18V

**LXT BL XPT**  
 MOTOR EXTREME PROTECTION TECHNOLOGY

Dĺžka noža	600 mm
Max. rezný výkon	23,5 mm
Počet strihov/min	Max/priemer/min
	0 - 4.400 / 0 - 3.600 / 0 - 2.000
Rozmery	1.121×192×225 mm
Hmotnosť	3,9 - 4,3 kg

**DUH602RT**  
 467,99 €

**DUH602Z**  
 324,99 €

## Aku plotostrih

DUH751 750 mm

Li-ion



ilustračný obrázok



18V

**LXT BL XPT**  
 MOTOR EXTREME PROTECTION TECHNOLOGY

Dĺžka noža	750 mm
Max. rezný výkon	23,5 mm
Počet strihov/min	Max/priemer/min
	0 - 4.400 / 0 - 3.600 / 0 - 2.000
Rozmery	1.261×192×225 mm
Hmotnosť	4,1 - 4,5 kg

**DUH751PTE**  
 665,99 €

**DUH751Z**  
 384,99 €

## Aku plotostrih

DUH754 750 mm

Li-ion



18V

**LXT BL XPT**  
 MOTOR EXTREME PROTECTION TECHNOLOGY

Dĺžka noža	750 mm
Max. rezný výkon	23,5 mm
Počet strihov/min	Max/priemer/min
(SPM)	0 - 4.400 / 0 - 3.600 / 0 - 2.000
Rozmery	1.198×280×147 mm
Hmotnosť	4,1 kg

**DUH754SZ**  
 499,99 €

## Aku plotostrih

DUN500 500 mm

Li-ion



18V

**LXT BL XPT**  
 MOTOR EXTREME PROTECTION TECHNOLOGY

Dĺžka noža	500 mm
Max. rezný výkon	23,5 mm
Uroveň akustického tlaku	81,5 dB(A)
Uroveň akustického výkonu	92,5 dB (A)
Počet strihov/min	Max / priemer / min
	4.400 / 3.600 / 2.000
Celková dĺžka	2.115 mm
Hmotnosť	4,5 kg

**DUN500WZ**  
 411,99 €



18V



Dĺžka noža	460 mm
Počet strihov za minútu	3.600
Max. strihací výkon	18 mm
Úroveň akustického tlaku	74 dB(A)
Vibrácie	2,5 m/s <sup>2</sup>
Rozmery	1.889 – 2.511×87×134 mm
Hmotnosť	3,0 – 3,3 kg

LXT XPT  
EXTREME PROTECTION TECHNOLOGY

DUN461WSF  
269,99 €

DUN461WZ  
173,99 €



▲ DUR190L

18V



Šírka rezného nástroja	Žacia hlava: 300 mm
	Plastový nôž: 255 mm
	Železný nôž: 230 mm
Voľnobežné otáčky / min <sup>-1</sup>	3.500 – 6.000
Uchytenie nástroja na vretene	M10 × 1,25 LH
Hmotnosť	DUR190U: 3,1 – 3,4 kg
	DUR190L: 2,9 – 3,2 kg

ADT AFT  
LXT BL MOTOR XPT  
EXTREME PROTECTION TECHNOLOGY



DUR190LZX3  
238,99 €

DUR190UZX3  
260,99 €



▲ DUR191L

18V



Šírka rezného nástroja	Žacia hlava: 300 mm
	Plastový nôž: 255 mm
	Železný nôž: 230 mm
Voľnobežné otáčky / min <sup>-1</sup>	3.500 – 6.000
Uchytenie nástroja na vretene	M8 × 1,25 LH
Hmotnosť	DUR191U: 3,4 – 3,7 kg
	DUR191L: 3,2 – 3,5 kg

ADT AFT  
LXT BL MOTOR XPT  
EXTREME PROTECTION TECHNOLOGY



DUR191LZX3  
288,99 €

DUR191UZX3  
319,99 €



18V



Šírka rezného nástroja	Nylónová hlava 300 mm
Voľnobežné otáčky / min <sup>-1</sup>	Max 0 – 6.000 / Min: 0 – 4.500,
Uchytenie nástroja na vretene	M10×1,25 LH
Rozmery	1.670×186×246 mm
Hmotnosť	2,7 – 3,0 kg

LXT  
BL ADT MOTOR XPT  
EXTREME PROTECTION TECHNOLOGY



DUR192LZ  
196,99 €



18V

Šírka rezného nástroja	Žacia hlava: 260 mm
Voľnobežné otáčky / min <sup>-1</sup>	7.800
Rozmery	1.194 – 1.384 × 271 × 372 mm
Hmotnosť	2,4 – 2,7 kg

LXT XPT  
EXTREME PROTECTION TECHNOLOGY

DUR193RF  
269,99 €

DUR193Z  
135,99 €

## Aku krovinořez

DUR194

NOVINKA

Li-ion



18V

**LXT XPT**  
EXTREME PROTECTION TECHNOLOGY

Šírka rezného nástroja	Žacia hlava: 260 mm
	Kovový nôž: 200 mm
	Plastový nôž: 230 mm
Voľnobežné otáčky / min <sup>-1</sup>	Max / Min: 6.000 / 4.500
Uchytenie nástroja na vretene	M10 x 1,25 LH
Rozmery	1.630 - 288 x 236 mm
Hmotnosť	2,6 - 2,9 kg

**DUR194ZX1**  
**199,99 €**

## Aku vyžinač

DUR189

Li-ion



18V

**LXT**  
**BL ADT XPT**  
MOTOR EXTREME PROTECTION TECHNOLOGY

Voľnobežné otáčky / min <sup>-1</sup>	Max / Priemer / Min / ADT mód
Šírka rezného nástroja	6.000 / 5.000 / 4.000 / 4.000 - 6.000
	Žacia hlava: 300 mm
	Plastový nôž: 255 mm
Uchytenie nástroja na vretene	M8x1,25 RH
Rozmery	1.518 - 1.618x258x369 mm
Hmotnosť	3,0 - 3,3 kg

**DUR189Z**  
**244,99 €**

## Aku vyžinač

DUR181

Li-ion



18V

**LXT**

Šírka rezného nástroja	Žacia hlava: 260 mm
Voľnobežné otáčky / min <sup>-1</sup>	7.800
Úroveň akustického tlaku	82 dB(A)
Úroveň akustického výkonu	88,5 dB(A)
Vibrácie	2,5 m/s <sup>2</sup>
Rozmery	1.229 - 1.433x267x186 - 257 mm
Hmotnosť	2,8 - 3,1 kg

**DUR181Z**  
**97,99 €**

## Aku krovinořez

DUX18

Li-ion



18V

**LXT BL AFT XPT**  
MOTOR EXTREME PROTECTION TECHNOLOGY

Voľnobežné otáčky / min <sup>-1</sup>	Max: 0 - 9.700; Min: 0 - 6.800
Rozmery	977x318x175 mm
Hmotnosť	2,8 - 10,3 kg

**DUX18ZX1**  
**291,99 €**

## Aku nožnice na trávnu

DUM604 160 mm

Li-ion



18V

**LXT**

Šírka rezného nástroja	160 mm
Nastavenie výšky strihu	15, 20, 25 mm
Počet strihov za minútu	2.500
Úroveň akustického tlaku	76 dB(A)
Vibrácie	2,5 m/s <sup>2</sup>
Rozmery	337x177x131 mm
Hmotnosť	1,4 - 1,8 kg

**DUM604RF**  
**202,99 €**
**DUM604ZX**  
**103,99 €**

X - nôž na trávnu/nôž na živý plot



## Aku nožnice na trávu

DUM111

Li-ion



Šírka rezného nástroja	110 mm
Počet strihov za minútu	2.500
Rozmery	333x120x131 mm
Hmotnosť	1,4 – 1,7 kg

18V

LXT

DUM111SYX  
155,99 €

DUM111ZX  
69,99 €

X – nôž na trávu/nôž na živý plot

## Aku fukár

DUB184

Li-ion



Max. prietok vzduchu	13,0 m³/min
Rýchlosť vzduchu	52,1 m/s
Voľnobežné otáčky / min⁻¹	0 – 18.000
Úroveň akustického tlaku	86,6 dB(A)
Úroveň akustického výkonu	93,5 dB(A)
Vibrácie	2,5 m/s²
Rozmery	825x160x285 mm
Hmotnosť	2,5 – 3,0 kg

18V

LXT BL XPT  
MOTOR EXTREME PROTECTION TECHNOLOGY



DUB184RT  
291,99 €

DUB184Z  
151,99 €

## Aku rýchlovarná kanvica

DKT360

NOVINKA

Li-ion



Približný čas zohriatia	8 min (0,8L vody z 23 °C)
Water tank capacity	0,8 L
Dimensions (LxWxH)	233x263x307 mm
Net weight	2,7 – 3,4 kg

18V

LXT

DKT360Z  
202,99 €

## Aku chladnička / ohrievač

DCW180

Li-ion



Objem	20 L
Chladiaci systém	Kompresor
Nastavenie chladenia	-18 / -10 / 0 / 5 / 10 °C
Zohrievací systém	Ohrievač
Nastavenie zohrievania	55 / 60 °C
Pracovný čas	s/ BL1860B X2, -18 °C / 5 °C / 60 °C: 5h / 17h / 4h
Dĺžka kábla	EI. kábel 2 m / kábel do zapalovača 2,5 m
Hmotnosť	13,3 – 14,3 kg

18V

LXT

DCW180Z  
727,99 €

## Aku postrekovač

DUS054

NOVINKA

Li-ion



Max. tlak	0,3 Mpa / 3 Bar
Objem nádrže	5 L
Dĺžka hadice	1,7 m
Dĺžka nadstavca	0,5 – 0,7 m
Rozmery	343x182x368 mm
Hmotnosť	3,2 – 3,5 kg

18V

LXT XPT  
EXTREME PROTECTION TECHNOLOGY

DUS054Z  
219,99 €

# 12V<sub>max</sub> LITHIUM-ION

ROZŠÍŘTE SI SVOJ LI-ION SORTIMENT

4,0Ah 2,0Ah 1,5Ah

SK209GD / SK312GD  
SK40GD / SK20GD / SK10GD

SK700GD / SK700D

SK106GD / SK106D

SK105GD / SK105D

DMR200 / DMR201  
DMR202 / DMR203

DMR107 / DMR108  
DMR109 / DMR110  
DMR112 / DMR114  
DMR115 / DMR300  
DMR301 / MR052

DF332D / DF032D  
DF333D / DF033D

DA332D / DA333D

HP332D / HP333D

TW140D / TW141D  
TW160D / TW161D  
TW060D

TD110D / TD111D

HR140D / HR166D

WR100D

TL064D / TL065D

CP100D

SC103D

HS301D

JR103D / JR105D

CC301D

SD100D

JV101D / JV102D / JV103D

PV301D

PT354D

TM30D

ST113D

ADP08 / ADP06

UB100D / UB101D

UH201D

ML103 / ML104  
ML105 / ML106

Grass Shear UM600D

Grass Trimmer UR100D

CG100D

UN460WD

US053D

MP100D

CL106D / CL107D  
CL108D / CL121D

DFJ212 / DFJ213  
DFJ214

Fan Vest DFV210

CJ105D / CJ106D

CV102D

CB100D

CF100D / CF101D





## Aku skrutkovač

DF333D 10 mm / DF033D 1/4"

Li-ion



DF033D



DF333D



	DF333D	DF033D
Max. vrtací výkon	Železo / Drevo: 10 / 21 mm 0,8 – 10 mm	Železo / Drevo: 10 / 21 mm 1/4"
Rozsah skľučovadla	0,8 – 10 mm	1/4"
Voľnobežné otáčky / min <sup>-1</sup>	Max / Min: 0 – 1.700 / 0 – 450	Max / Min: 0 – 1.700 / 0 – 450
Max. ťahovací moment	Tvrдый / mäkký spoj: 30 / 14 N·m	Tvrдый / mäkký spoj: 30 / 14 N·m
Max. povoľovací moment	28 N·m	28 N·m
Vibrácie	Vrtanie do železa: 2,5 m/s <sup>2</sup>	Vrtanie do železa: 2,5 m/s <sup>2</sup>
Úroveň akustického tlaku	70 dB(A)	70 dB(A)
Max. výkon	170 W	170 W
Rozmery	179×66×229 mm	149×66×229 mm
Hmotnosť	1,1 – 1,2 kg	0,9 – 1,1 kg



DF333DSAE  
155,99 €

DF333DSME  
187,99 €

DF333DSAP1  
129,99 €

DF333DZ  
65,99 €

DF033DSAE  
155,99 €

DF033DZ  
54,99 €

## Aku skrutkovač

DF332D 10 mm / DF032D 1/4"

Li-ion



DF332D



DF032D



	DF332D	DF032D
Max. vrtací výkon	Železo / Drevo: 10 / 28 mm 0,8 – 10 mm	Železo / Drevo: 10 / 28 mm 1/4"
Rozsah skľučovadla	0,8 – 10 mm	1/4"
Voľnobežné otáčky / min <sup>-1</sup>	Max / Min: 0 – 1.500 / 0 – 450	Max / Min: 0 – 1.500 / 0 – 450
Max. ťahovací moment	Tvrдый / mäkký spoj: 35 / 21 N·m	Tvrдый / mäkký spoj: 35 / 21 N·m
Max. povoľovací moment	32 N·m	32 N·m
Vibrácie	Vrtanie do železa: 2,5 m/s <sup>2</sup>	Vrtanie do železa: 2,5 m/s <sup>2</sup>
Úroveň akustického tlaku	72 dB(A)	71 dB(A)
Max. výkon	250 W	250 W
Rozmery	154×66×217 mm	124×66×217 mm
Hmotnosť	1,0 – 1,2 kg	0,88 – 1 kg



DF332DSAE  
218,99 €

DF332DSME  
249,99 €

DF332DZ  
129,99 €

DF032DSAE  
237,99 €

DF032DSME  
271,99 €

DF032DZ  
129,99 €

## Aku skrutkovač

HP333D 10 mm

Li-ion



Max. vrtací výkon	Železo / Drevo / Murivo: 10 / 21 / 8 mm
Rozsah skľučovadla	0,8 – 10 mm
Počet úderov za minútu	Max / Min: 0 – 25.500 / 0 – 6.750
Voľnobežné otáčky / min <sup>-1</sup>	Max / Min: 0 – 1.700 / 0 – 450
Max. ťahovací moment	Tvrдый / mäkký spoj: 30 / 14 N·m
Max. povoľovací moment	28 N·m
Vibrácie	Vrtanie s príklepom do betónu: 13 m/s <sup>2</sup> Vrtanie do železa: 2,5 m/s <sup>2</sup>
Úroveň akustického tlaku	82 dB(A)
Úroveň akustického výkonu	93 dB(A)
Rozmery	193×66×229 mm
Hmotnosť	1,1 – 1,3 kg



HP333DSAE  
168,99 €

HP333DZ  
75,99 €

## Aku skrutkovač

HP332D 10 mm

Li-ion



Max. vrtací výkon	Železo / Drevo / Murivo: 10 / 28 / 8 mm
Rozsah skľučovadla	0,8 – 10 mm
Počet úderov za minútu	Max / Min: 0 – 22.500 / 0 – 6.750
Voľnobežné otáčky / min <sup>-1</sup>	Max / Min: 0 – 1.500 / 0 – 450
Max. ťahovací moment	Tvrдый / mäkký spoj: 35 / 21 N·m
Max. povoľovací moment	32 N·m
Vibrácie	Vrtanie s príklepom do betónu: 12,5 m/s <sup>2</sup> Vrtanie do železa: 2,5 m/s <sup>2</sup>
Úroveň akustického tlaku	82 dB(A)
Úroveň akustického výkonu	93 dB(A)
Rozmery	168×66×217 mm
Hmotnosť	1,1 – 1,3 kg



HP332DSAE  
227,99 €

HP332DSME  
259,99 €

HP332DZ  
141,99 €

## Aku uhlová vrtáčka

DA333D / DA332D 10 mm

Li-ion



DA333D

DA332D



	DA333D	DA332D
Max. vrtací výkon	Železo: 10 mm Drevo: 12 mm	Železo: 10 mm Drevo: 12 mm
Voľnobežné otáčky / min <sup>-1</sup>	0 – 1.100	0 – 1.100
Výška hlavy	84 mm	63 mm
Výška tela stroja	23,5 mm	23,5 mm
Vibrácie	Vrtanie do železa: 3,0 m/s <sup>2</sup>	Vrtanie do železa: 2,5 m/s <sup>2</sup>
Úroveň akustického tlaku	70 dB(A)	70 dB(A)
Rozmery	s BL1016/BL1021B : 313×68×95 mm s BL1041B : 332×68×95 mm	s BL1016/BL1021B : 313×68×86 mm s BL1041B : 332×68×86 mm
Hmotnosť	1,2 – 1,4 kg	1,2 – 1,3 kg



DA333DSAE  
227,99 €

DA332DSAE  
216,99 €



## Aku rázový uťahovač

TW060D

Li-ion

12V<sub>MAX</sub>

Max. uťahovací výkon	Skrutka štandardná: M8 – M12 Skrutka vysokopevnosťná: M6 – M10
Upínanie	3/4"
Voľnobežné otáčky / min <sup>-1</sup>	0 – 2.600
Počet úderov za minútu	0 – 3.200
Max. uťahovací moment	60 N·m
Hmotnosť	1,0 – 1,2 kg

CXT

TW060DSAE  
205,99 €TW060DZ  
65,99 €

## Aku rázový uťahovač

TW161

Li-ion

12V<sub>MAX</sub>

Max. uťahovací výkon	Skrutka štandardná: M8 – M16 Skrutka vysokopevnosťná: M6 – M12
Upínanie	1/2"
Voľnobežné otáčky / min <sup>-1</sup>	Max / min: 0 – 2.400 / 0 – 1.300
Počet úderov za minútu	Max / min: 0 – 3.600 / 0 – 2.000
Max. uťahovací moment	165 N·m
Hmotnosť	1,1 – 1,2 kg

CXT BL  
MOTORTW161DSAE  
269,99 €TW161DZ  
139,99 €

## Aku rázový uťahovač

TW141

Li-ion

12V<sub>MAX</sub>

Max. uťahovací výkon	Skrutka štandardná: M8 – M16 Skrutka vysokopevnosťná: M6 – M12
Upínanie	1/2"
Voľnobežné otáčky / min <sup>-1</sup>	0 – 2.600
Počet úderov za minútu	0 – 3.200
Max. uťahovací moment	145 N·m
Hmotnosť	1,1 – 1,2 kg

CXT

TW141DSAE  
207,99 €TW141DZ  
65,99 €

## Aku rázový uťahovač

TW140D

Li-ion

12V<sub>MAX</sub>

Max. uťahovací výkon	Skrutka štandardná: M8 – M16 Skrutka vysokopevnosťná: M6 – M12
Upínanie	3/8"
Voľnobežné otáčky / min <sup>-1</sup>	0 – 2.600
Počet úderov za minútu	0 – 3.200
Max. uťahovací moment	140 N·m
Hmotnosť	1,0 – 1,2 kg

CXT

TW140DSMJ  
249,99 €TW140DZ  
65,99 €

## Aku rázový skrutkovač

TD112D

NOVINKA

Li-ion

12V<sub>MAX</sub>

Max. uťahovací výkon	Skrutka so šesťhrannou hlavou: M5 – M12 mm Skrutka štandardná: M5 – M14 Skrutka vysokopevnosťná: M5 – M12
Upínanie	1/4"
Voľnobežné otáčky / min <sup>-1</sup>	Tvrдый / mäkký spoj: 0 – 3.000 / 0 – 2.000
Počet úderov za minútu	Tvrдый / mäkký spoj: 0 – 3.900 / 0 – 3.300
Max. uťahovací moment	135 N·m
Vibrácie	10,9 m/s <sup>2</sup>
Úroveň akustického tlaku	104 dB(A)
Úroveň akustického výkonu	93 dB(A)
Rozmery	145×64×221 mm
Hmotnosť	0,99 – 1,2 kg

CXT BL  
MOTORTD112DMZ  
166,99 €

## Aku rázový skrutkovač

TD111D

Li-ion



12V MAX



Max. ťahovací výkon	Skrutka so šesťhrannou hlavou: M4 – M8 mm Skrutka štandardná: M5 – M14 Skrutka vysokopevnostná: M5 – M12
Upínanie	1/4"
Voľnobežné otáčky / min <sup>-1</sup>	Tvrdý / mäkký spoj: 0 – 3.000 / 0 – 1.300
Počet úderov za minútu	Tvrdý / mäkký spoj: 0 – 3.900 / 0 – 1.600
Max. ťahovací moment	135 N·m
Vibrácie	12,5 m/s <sup>2</sup>
Úroveň akustického tlaku	94 dB(A)
Úroveň akustického výkonu	105 dB(A)
Rozmery	135×66×210 mm
Hmotnosť	0,97 – 1,1 kg

**CXT** **BL** **XPT**  
MOTOR EXTREME PROTECTION TECHNOLOGY

TD111DSAE  
239,99 €

TD111DZ  
119,99 €

## Aku rázový skrutkovač

TD110D

Li-ion



12V MAX



Max. ťahovací výkon	Skrutka so šesťhrannou hlavou: M4 – M8 mm Skrutka štandardná: M5 – M12 Skrutka vysokopevnostná: M5 – M10
Upínanie	1/4"
Voľnobežné otáčky / min <sup>-1</sup>	0 – 2.600
Počet úderov za minútu	0 – 3.500
Max. ťahovací moment	110 N·m
Vibrácie	8,0 m/s <sup>2</sup>
Úroveň akustického tlaku	94 dB(A)
Úroveň akustického výkonu	105 dB(A)
Max. výkon	120 W
Rozmery	153×66×204 mm
Hmotnosť	1,0 – 1,2 kg

**CXT**

TD110DSAE  
184,99 €

TD110DSME  
232,99 €

TD110DZ  
54,99 €

## Aku uhlový rázový skrutkovač

TL064D

Li-ion



12V MAX



Max. ťahovací výkon	Skrutka so šesťhrannou hlavou: M4 – M8 Skrutka štandardná: M4 – M12 Skrutka vysokopevnostná: M4 – M8
Upínanie	1/4"
Voľnobežné otáčky / min <sup>-1</sup>	0 – 2.000
Počet úderov za minútu	0 – 3.000
Max. ťahovací moment	60 N·m
Vibrácie	15,0 m/s <sup>2</sup>
Úroveň akustického tlaku	91 dB(A)
Úroveň akustického výkonu	102 dB(A)
Rozmery	361×66×86 mm
Hmotnosť	1,2 – 1,6 kg

**CXT**

TL064DSAJ  
357,99 €

## Aku uhlový rázový skrutkovač

TL065D

Li-ion



12V MAX



Max. ťahovací výkon	Skrutka štandardná: M4 – M12 Skrutka vysokopevnostná: M4 – M8
Upínanie	3/8"
Voľnobežné otáčky / min <sup>-1</sup>	0 – 2.000
Počet úderov za minútu	0 – 3.000
Max. ťahovací moment	60 N·m
Vibrácie	18,0 m/s <sup>2</sup>
Úroveň akustického tlaku	90 dB(A)
Úroveň akustického výkonu	101 dB(A)
Rozmery	361×66×86 mm
Hmotnosť	1,2 – 1,6 kg

**CXT**

TL065DSAJ  
378,99 €

## Aku uhlový rázový skrutkovač

WR100

Li-ion



12V MAX



Max. ťahovací výkon	Skrutka štandardná: M5 – M12 Skrutka vysokopevnostná: M5 – M10
Upínanie	3/8" / 1/4"
Voľnobežné otáčky / min <sup>-1</sup>	0 – 800
Max. ťahovací moment	47,5 N·m
Vibrácie	2,5 m/s <sup>2</sup>
Úroveň akustického tlaku	74 dB(A)
Rozmery	341×67×84 mm
Hmotnosť	1,0 – 1,2 kg

**CXT** **XPT**  
EXTREME PROTECTION TECHNOLOGY

WR100DSM  
291,99 €

WR100DSA  
269,99 €

WR100DZ  
173,99 €

## Aku vrtacie kladivo

HR166D 16 mm

Li-ion

12V<sub>MAX</sub>

Energia príklepu	EPTA-Procedure 05/2009: 1,1 J
Max. vrtací výkon	Betón: 16 mm Železo: 10 mm Drevo: 13 mm
Počet úderov / min <sup>-1</sup>	0 – 4.800
Voľnobežné otáčky / min <sup>-1</sup>	0 – 680
Vibrácie	Vrtanie s príklepom do betónu: 7,5 m/s <sup>2</sup> Vrtanie do železa: 2,5 m/s <sup>2</sup>
Úroveň akustického tlaku	86 dB(A)
Úroveň akustického výkonu	97 dB(A)
Rozmery	s BL1016/BL1021B: 250×74×187 mm s BL1041B: 250×74×206 mm
Hmotnosť	1,8 – 2,4 kg

CXT BL MOTOR

HR166DSMJ  
324,99 €HR166DZ  
162,99 €

## Aku vrtacie kladivo

HR140D 14 mm

Li-ion

12V<sub>MAX</sub>

Energia príklepu	EPTA-Procedure 05/2009: 1,0 J
Max. vrtací výkon	Betón: 14 mm Železo: 10 mm Drevo: 13 mm
Počet úderov za minútu	0 – 4.900
Voľnobežné otáčky / min <sup>-1</sup>	0 – 850
Vibrácie	Vrtanie s príklepom do betónu: 6,5 m/s <sup>2</sup> Vrtanie do železa: 3,0 m/s <sup>2</sup>
Úroveň akustického tlaku	84 dB(A)
Úroveň akustického výkonu	95 dB(A)
Rozmery	s BL1016/BL1021B: 246×74×179 mm s BL1041B: 246×74×198 mm
Hmotnosť	1,9 – 2,6 kg

CXT

HR140DSMJ  
291,99 €HR140DZ  
119,99 €

## Aku strihač závitových tyčí

SC103

Li-ion

12V<sub>MAX</sub>

Max. rezný výkon	Železo: M10 Nerez: W3/8
Min dĺžka strihu	20 mm
Počet strihov	Železo M10 s BL1041B: 550 ks
Rozmery	180×107×289 mm
Hmotnosť	2,7 – 2,8 kg

CXT BL MOTOR

SC103DZ  
648,99 €

## Aku rezačka na mokro

CC301D 85 mm

Li-ion

12V<sub>MAX</sub>

Priemer kotúča	85 mm
Max. rezný výkon	90°: 25,5 mm 45°: 16,5 mm
Voľnobežné otáčky / min <sup>-1</sup>	1.600
Objem nádrže	Voda: 0,5 L
Vibrácie	Rez v betóne: 2,5 m/s <sup>2</sup>
Úroveň akustického tlaku	84 dB(A)
Úroveň akustického výkonu	95 dB(A)
Rozmery	313×170×125 mm
Hmotnosť	1,9 kg

CXT

CC301DSMJ  
357,99 €CC301DZ  
155,99 €

## Aku leštička

PV301

Li-ion

12V<sub>MAX</sub>

Priemer brúsneho kotúča	Leštenie: 80 mm Brúsenie: 50 mm
Voľnobežné otáčky	Leštenie: 0 – 2.800 Brúsenie: 0 – 9.500
Rozmery	137×67×201 mm
Hmotnosť	1,1 – 1,2 kg

CXT BL MOTOR XPT

PV301DZ  
259,99 €



**Aku rezač**

CP100D

**Li-ion**



12V<sub>MAX</sub>



Max. rezný výkon	6 mm
Voľnobežné otáčky / min <sup>-1</sup>	300
Vibrácie	Rez kartónu: 2,5 m/s <sup>2</sup>
Úroveň akustického tlaku	70 dB(A)
Rozmery	s BL1016/BL1021B: 272×66×120 mm
	s BL1041B: 291×66×121 mm
Hmotnosť	0,72 – 0,88 kg

**CXT**

**CP100DWA**  
176,99 €

**Aku vyhrievaná vesta**

CV102D

**NOVINKA**

**Li-ion**



12V<sub>MAX</sub>



Veľkosť	S / M / L / XL / 2XL / 3XL
---------	----------------------------

**CV102DZ2XL**  
151,99 €

**CV102DZXL**  
151,99 €

**Aku multifunkčné náradie**

TM30D

**Li-ion**



12V<sub>MAX</sub>



Počet kmitov za minútu	6.000 – 20.000
Uhol kmitu	Vľavo/vpravo/spolu: 1,6° / 1,6° / 3,2°
Max. výkon	170 W
Hmotnosť	1,1 – 1,3 kg

**CXT**

**TM30DWYE**  
216,99 €

**TM30DZ**  
103,99 €

**Aku kotúčová píla**

HS301D 85 mm

**Li-ion**



12V<sub>MAX</sub>



Priemer kotúča	85 mm
Max. rezný výkon	90°: 25,5 mm 45°: 16,5 mm
Voľnobežné otáčky / min <sup>-1</sup>	1.500
Vibrácie	Rez v dreve: 2,5 m/s <sup>2</sup>
Úroveň akustického tlaku	71 dB(A)
Max. výkon	160 W
Rozmery	313×170×155 mm
Hmotnosť	1,6 – 1,7 kg

**CXT**

**HS301DSME**  
269,99 €

**HS301DZ**  
108,99 €

**Aku priamočiara píla**

JV103D

**Li-ion**



12V<sub>MAX</sub>



Max. rezný výkon pri 90°	Drevo/hlinik/mäkká oceľ: 90 / 20 / 10 mm
Dĺžka kmitu	23 mm
Počet kmitov za minútu	800 – 3.000
Vibrácie	Rez v drevených platniach: 8,5 m/s <sup>2</sup> Rez v železných platniach: 6,0 m/s <sup>2</sup>
Úroveň akustického tlaku	85 dB(A)
Úroveň akustického výkonu	96 dB(A)
Rozmery	237×76×206 mm
Hmotnosť	1,9 – 2,0 kg

**CXT** **BL**  
MOTOR

**JV103DSMJ**  
324,99 €

**JV103DZ**  
151,99 €

## Aku priamočiara píla

JV101D

Li-ion

12V<sub>MAX</sub>

Max. rezný výkon pri 90°	Drevo/hliník/mäkka oceľ:
	65 / 4 / 2 mm
Dĺžka kmitu	18 mm
Počet kmitov za minútu	0 – 2.900
Vibrácie	Rez v drevených platniach: 7,0 m/s <sup>2</sup>
	Rez v železných platniach: 5,5 m/s <sup>2</sup>
Úroveň akustického tlaku	80 dB(A)
Úroveň akustického výkonu	91 dB(A)
Rozmery	232x76x196 mm
Hmotnosť	1,8 – 1,9 kg

CXT

JV101DSME  
259,99 €JV101DZ  
87,99 €

## Aku chvostová píla

JR105D / JR103D

Li-ion

12V<sub>MAX</sub>

JR105D



Dĺžka kmitu	13 mm
Počet kmitov za minútu	0 – 3.300
Max. rezný výkon	Rúra/drevo: 50 / 50 mm
Vibrácie	Rez platni: 8,0 m/s <sup>2</sup>
	Drevené hrady: 8,0 m/s <sup>2</sup>
Úroveň akustického tlaku	78 dB(A)
Max. výkon	210 W
Rozmery	376x66x186 mm
Hmotnosť	1,3 – 1,5 kg

CXT

JR105DSME  
276,99 €JR105DZ  
97,99 €JR103DSAE  
218,99 €JR103DSME  
269,99 €JR103DZ  
97,99 €

## Aku ventilátor

CF101D

Li-ion

12V<sub>MAX</sub>

Pracovný čas (min.)	s BL1041B:
	Min. / Priemer / Max.: 630 / 380 / 275
Rozmery	185x260x284 mm
Hmotnosť	1,3 – 1,7 kg

Dodávaný bez sieťového adaptéra

CXT

CF101DZ  
84,99 €

## Aku sponkovačka

ST113D

Li-ion

12V<sub>MAX</sub>

Sponky	Šírka: 10 mm
	Dĺžka: 7 – 10 mm
	Kaliber: 0,5x0,7 mm
Kapacita zásobníka	150 (max 160)
Vibrácie	2,5 m/s <sup>2</sup>
Úroveň akustického tlaku	75 dB(A)
Rozmery	211x81x159 mm
Hmotnosť	1,3 kg

CXT XPT  
EXTREM PROTECTION TECHNOLOGYST113DSAJ  
432,99 €

## Aku pištoľ na silikón

CG100D

Li-ion

12V<sub>MAX</sub>

Max. tlak	5.000 N
Vofnobežné otáčky / min <sup>-1</sup>	0 – 28 mm/sec. (0 – 66 in/min.)
Veľkosť nastavcov	300. 600. 800 mL
Úroveň akustického tlaku	70 dB(A)
Vibrácie	Bez zataženia: 2,5 m/s <sup>2</sup>
Rozmery	404x108x259 mm
Hmotnosť	1,9 – 2,6 kg

CXT

CG100DSAA  
324,99 €

## Aku vyžinač

UR100D

Li-ion



12V<sub>MAX</sub>



X – plastový nôž



Šírka rezného nástroja	Žacia hlava: 260 mm
	Plastový nôž: 230 mm
Voľnobežné otáčky / min <sup>-1</sup>	Žacia hlava: 9.000
	Plastový nôž: 10.000
Uchytenie nástroja na vretene	M8x1,25 RH
Rozmery	835 – 1.185x267x210 – 315 mm
Hmotnosť	2,1 – 2,3 kg

**CXT XPT**  
EXTREME PROTECTION TECHNOLOGY

UR100DSAEX  
207,99 €

UR100DSAP  
187,99 €

UR100DWAEX  
209,99 €

UR100DZ  
128,99 €

UR100DZX  
113,99 €

## Aku strihač trávy

UM600D 160 mm

Li-ion



12V<sub>MAX</sub>



Šírka rezného nástroja	160 mm
Nastavenie výšky strihu	15. 20. 25 mm
Počet strihov za minútu	2.500
Úroveň akustického tlaku	75 dB(A)
Vibrácie	2,5 m/s <sup>2</sup>
Rozmery	329x177x131 mm
Hmotnosť	1,3 – 1,5 kg

**CXT 2in1 XPT**  
EXTREME PROTECTION TECHNOLOGY

X – nôž na trávu/nôž na živý plot

UM600DWAEX  
176,99 €

UM600DZX  
103,99 €

UM600DSAP  
179,99 €

## Aku fukár

UB100D

Li-ion



12V<sub>MAX</sub>



Max. prietok vzduchu	2,6 m <sup>3</sup> /min
Rychlosť vzduchu	75 m/s
Tlak vzduchu	4,0 kPa
Voľnobežné otáčky / min <sup>-1</sup>	0 – 15.800
Úroveň akustického tlaku	74 dB(A)
Vibrácie	2,5 m/s <sup>2</sup>
Hmotnosť	1,4 – 1,9 kg

**CXT**

UB100DZ  
72,99 €

## Aku fukár

UB101D

Li-ion



12V<sub>MAX</sub>



Max. prietok vzduchu	2,6 m <sup>3</sup> /min
Rychlosť vzduchu	56 m/s
Voľnobežné otáčky / min <sup>-1</sup>	0 – 15.800
Úroveň akustického tlaku	74,6 dB(A)
Úroveň akustického výkonu	86,3 dB(A)
Vibrácie	2,5 m/s <sup>2</sup>
Hmotnosť	1,4 – 1,9 kg

**CXT**

UB101DZ  
97,99 €

## Aku / elektrické LED svetlo

DML805 18 V, 14,4 V / AC

Li-ion



18V

14.4V



Čas svietenia	Max 17 hodín / podľa akumulátora/
Svietivosť	Max: 750 lm. Min: 450 lm
Hmotnosť	2,3 – 2,7 kg
Dĺžka privádzajúceho kábla	2,5 m

**LXT**

DEADML805  
141,99 €



## Aku LED lampa

DML802 18 V, 14.4 V

Li-ion



18V

14.4V

Čas svietenia	Max 27 hodín /podľa akumulátora/
Rozmery	272x79x116 mm
Hmotnosť	0,64 – 1,0 kg

LXT

DEADML802  
54,99 €

## Aku LED lampa

ML106 12 V max

Li-ion

12V<sub>MAX</sub>

Počet lumenov	190
Hmotnosť	0,61 – 0,78 kg

CXT

DEAML106  
54,99 €

## Aku LED lampa

ML105 12 V max

Li-ion

12V<sub>MAX</sub>

Čas svietenia	Max 14 hodín /podľa akumulátora/
Svietivosť	190 lm
Rozmery	s BL1016/BL1021B: 249x66x93 mm s BL1041B: 268x66x93 mm
Hmotnosť	0,53 – 0,70 kg

CXT

DEAML105  
54,99 €

## Aku LED lampa

ML104 12 V max

Li-ion

12V<sub>MAX</sub>

Čas svietenia	Max 19 hodín /podľa akumulátora/
Rozmery	414x66x132 mm
Hmotnosť	0,61 – 0,78 kg

CXT XPT  
EXTREME PROTECTION TECHNOLOGYDEAML104  
97,99 €

## Aku LED lampa

DML801 18 V, 14.4 V

Li-ion



18V

14.4V

Čas svietenia	Max 48 hodín /podľa akumulátora/
Rozmery	380x79x116 mm
Hmotnosť	0,61 – 0,98 kg

LXT

DEBDML801  
48,99 €

**Aku LED lampa**

**DML802** 18 V, 14,4 V

**Li-ion**



18V

14.4V



Čas svietenia	max. 27 hodín
Rozmery	272x79x116 mm
Hmotnosť	0,64 – 1 kg

**LXT**

**DEADML802**  
54,99 €

**Aku LED lampa**

**DML806** 18 V, 14,4 V

**Li-ion**



18V

14.4V

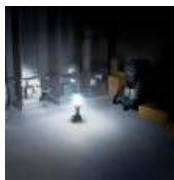

Počet lumenov	620
Hmotnosť	0,69 – 1,1 kg

**LXT**

**DEBDML806**  
65,99 €

**Aku LED lampa**

**DML808** 18 V, 14,4 V

**Li-ion**



18V

14.4V



Počet lumenov	190
Hmotnosť	0,73 – 1,09 kg

**LXT**

**DEADML808**  
65,99 €

**Aku LED lampa**

**DML815** 18 V, 14,4 V

**Li-ion**



18V

14.4V



Počet lumenov	160
Hmotnosť	0,26 – 0,93 kg

**LXT**

**DEBDML815**  
34,99 €

**Aku lampa**

**DML810**

**Li-ion**



18V

14.4V



Počet lumenov	Max / Piemer / Min: 5.500 / 3.000 / 1.500 lm
Hmotnosť	13,9 – 15,3 kg

**LXT**

**DML810**  
399,99 €

## Aku lampa

DML812

Li-ion



18V

14.4V



Počet lumenov 600/ 1.000/ 1.250 lm  
Hmotnosť 1,2 – 1,6 kg

**LXT XPT**  
EXTENDED PROTECTION TECHNOLOGY
**DML812**  
**141,99 €**

## Aku lampa

DML814

Li-ion



18V

14.4V



Počet lumenov Max / Priemer / Min 3.000 / 1.700 / 900 lm  
Hmotnosť 7,2 – 7,9 kg

**LXT**
**DML814**  
**368,99 €**

## Aku lampa

DML809

Li-ion



18V



Čas svietenia  
Max hodín / podľa akumulátora/ 7,5  
Rozmery 249 x 370 x 370 mm  
Hmotnosť 5,7 – 7,0 kg

**LXT**
**DML809**  
**303,99 €**

## Aku LED lampa

DML186

Li-ion



DML186

18V



Čas svietenia  
Max hodín / podľa akumulátora/ 114  
Rozmery 151×81×61 mm  
Hmotnosť 0,51 – 0,83 kg

**LXT**
**DEBDML186**  
**19,99 €**

## Aku LED lampa

ML103

Li-ion

12V<sub>MAX</sub>

Čas svietenia Max 28 hodín / podľa akumulátora/  
Rozmery bez akumulátora: 77×54×28 mm  
s BL1016/BL1021B: 87×64×54 mm  
s BL1041B: 87×64×73 mm  
Hmotnosť 0,27 – 0,43 kg

**CXT**
**DEAML103**  
**31,99 €**



640m

10 dopredu  
m  
(na stranu: 10m)

6 dopredu  
m  
(na stranu: 6m)

4,5 dopredu  
m  
(na stranu: 5,3m)

6,5 dopredu  
m  
(na stranu: 6,5m)

2,3 dopredu  
m  
(na stranu: 2,6m)

2,8 dopredu  
m  
(na stranu: 3m)

2,8 dopredu  
m  
Flood mode (na stranu: 3m)

DML805

ML003G

DML812

DML813 / DML814

DML811

DML810

DML809

\*merané podľa ANSI



18V

DML805

750 lm



18V

40V max

ML003G

1 100 lm



18V

DML812

1 250 lm  
Spot+Flood mode



18V

DML813  
DML814

3 000 lm



18V

DML811



18V

DML810

5 500 lm



18V

DML809

10 000 lm

## Aku ventilátor

DCF301 18 V / AC

NOVINKA

Li-ion



Max. rýchlosť vzduchu	Max / Priemer / Min: 21 / 15 / 10 m³/min
Max. prietok vzduchu	Max / Priemer / Min: 240 / 170 / 120 m³/min
Rozmery	269x439x602 mm
Hmotnosť	3,8 – 4,5 kg

18V



LXT

DCF301Z  
175,99 €

## Aku ventilátor

DCF203 18 V, 14,4 V / AC

Li-ion



Max. rýchlosť vzduchu	Max / Priemer / Min: 190 / 150 / 120 m³/min
Max. prietok vzduchu	Max / Priemer / Min: 8,2 / 6,5 / 5,2 m³/min
Rozmery	140x333x447 mm
Hmotnosť	1,9 – 2,6 kg

18V

14.4V



LXT

DCF203Z  
131,99 €

## Aku ventilátor

DCF201 18 V, 14,4 V / AC

Li-ion



Pracovný čas (min.)	Max.: 100–3,0 Ah. 45–1,3 Ah (18 V) /
	90–3,0 Ah. 40–1,3 Ah (14,4 V)
	Min.: 200–3,0 Ah. 90–1,3 Ah (18 V) /
	180–3,0 Ah. 80–1,3 Ah (14,4 V)
Rozmery	263x330x523 mm
Hmotnosť	2,5 – 2,9 kg

18V

14.4V



LXT

DCF201Z  
115,99 €

## Aku ventilátor

DCF102 18 V, 14,4 V / AC

Li-ion



Pracovný čas (min.)	s BL1860B:
	Min. / Priemer / Max.: 1270 / 705 / 575
Rozmery	185x272x284 mm
Hmotnosť	1,3 – 2,0 kg

18V

14.4V

LXT

DCF102Z  
85,99 €

## Aku kávovar

DCM501 18 V, 14,4 V, 12 V

Li-ion



Objem nádoby na vodu	250 mL
Rozmery	s BL1016/BL1021B: 87x64x54 mm
Hmotnosť	1,9 kg

18V

14.4V

12V<sup>MAX</sup>

Použitie len na akumulátory.

LXT CXT

DCM501Z  
129,99 €

**Aku vyhrievaná bunda**

DCJ205

**NOVINKA**

**Li-ion**



18V 14.4V



Veľkosť S / M / L / XL / 2XL / 3XL  
Počet stupňov vyhrievania 3

DCJ205ZL  
184,99 €

DCJ205ZM  
184,99 €

DCJ205ZXL  
184,99 €

**Aku vyhrievaná bunda**

DCJ206

**NOVINKA**

**Li-ion**



18V 14.4V



Počet stupňov vyhrievania 3

DCJ206ZL  
216,99 €

DCJ206ZM  
216,99 €

DCJ206ZXL  
216,99 €

**Aku vyhrievaná vesta**

DCV202

**NOVINKA**

**Li-ion**



18V 14.4V



Počet stupňov vyhrievania 3

DCV202Z2XL  
151,99 €

DCV202ZL  
151,99 €

**Aku vyhrievaná deka**

DCB200

**Li-ion**



18V 14.4V



Pracovný čas Max / priemer / min 35 / 20 / 10 hodín s BL1860B  
Rozmer 700x1.400 mm  
Hmotnosť 0,58 kg  
A – čierna farba  
B – hnedá farba

**LXT**

DCB200A  
133,99 €

**Aku vyhrievaná deka**

CB100

**Li-ion**



12V<sub>MAX</sub>



Pracovný čas Max / priemer / min 14 / 7,5 / 4 hodín s BL1041B  
Rozmer 700x1.400 mm  
Hmotnosť 0,58 kg  
A – čierna farba  
B – hnedá farba

**CXT**

CB100DA  
128,99 €



# Chladiace bundy

DFJ410



+



Adaptér zadarmo

DFJ211



DFJ310

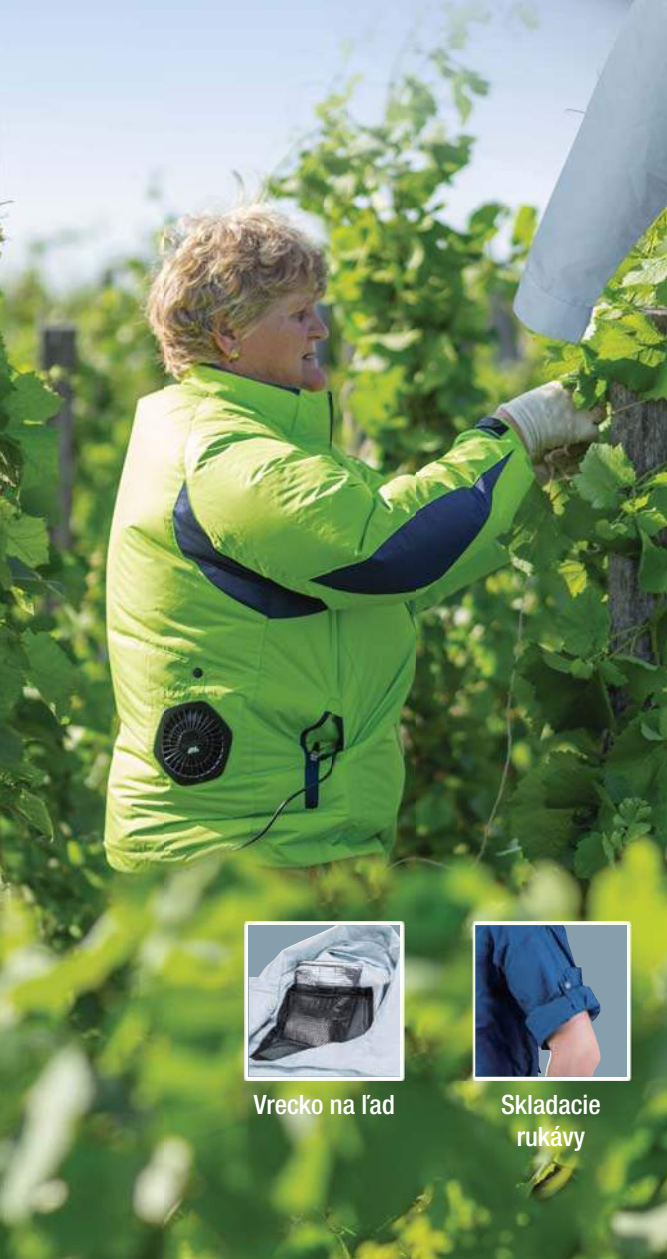

Vrečko na ľad



Skladacie rukávy

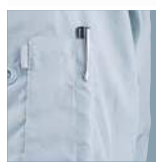

Vrečko na pero



Chrániče ramien



Kapučňa z mesh materiálu

Veľkosti bünd:  
L | XL | 2XL





Vnútrohá cirkulácia vzduchu



Priedušný, vode odolný materiál



Kvalitný zips



Suchý zips na rukávoch



Sťahovanie spodnej časti pre lepšiu cirkuláciu vzduchu



Vrecko na ramene





## Aku pumpa

MP100

Li-ion

12V<sub>MAX</sub>

Max. tlak vzduchu	830 kPa
Max. výkon	10 l / min
Hmotnosť	1,2 – 1,3 kg

CXT

MP100DZ  
94,99 €

## Aku rádio

DMR116

NOVINKA

Li-ion



18V



Frekvencia	FM / AM: 87,5 – 108 MHz / 522 – 1.710 kHz
Veľkosť reproduktorov	Ø 76 mm x2
Max. výkon	18 V: 3,5 W x2
Rozmery	257x163x431 mm
Hmotnosť	4,1 – 4,7 kg
USB nabíjanie	nie
USB prehrávanie	nie
Dodávané s AC adaptérom	

LXT

DMR116  
176,99 €

## Aku rádio

DMR115

Li-ion



18V

12V<sub>MAX</sub>

Frekvencia	FM / AM: 87,5 – 108 MHz
Veľkosť reproduktorov	Reproduktor: Ø63,5 mm x2 / spodný Ø101,6 mm
Max. výkon	18 V: 5 W x2 + 25 W 14,4 V: 3 W x2 + 15 W 12 V: 2 W x2 + 10 W
Bluetooth	Verzia: 5,0 Profil: TA2DP / SCMS-T / AVRCP Podporovaný kódok: SBC / AAC
Rozmery	268x164x437 mm
Hmotnosť	5,0 – 5,5 kg
USB nabíjanie	áno
USB prehrávanie	nie
Dodávané s AC adaptérom	

CXT LXT Bluetooth DAB+

DMR115  
306,99 €

## Aku rádio

DMR114

Li-ion



18V

12V<sub>MAX</sub>

Frekvencia	FM / AM: 87,5 – 108 MHz
Veľkosť reproduktorov	Reproduktor: Ø63,5 mm x2 / spodný Ø101,6 mm
Max. výkon	18 V: 5 W x2 + 25 W 14,4 V: 3 W x2 + 15 W 12 V: 2 W x2 + 10 W
Bluetooth	Verzia: 5,0 Profil: A2DP / SCMS-T / AVRCP Podporovaný kódok: SBC
Rozmery	268x164x437 mm
Hmotnosť	5,1 – 5,6 kg
USB nabíjanie	áno
USB prehrávanie	nie
Dodávané s AC adaptérom	

CXT LXT Bluetooth

DMR114  
279,99 €

## Aku rádio

DMR112

Li-ion



7.2V

18V

12V<sub>MAX</sub>

Frekvencia	FM / AM: 87,5 – 108 MHz
Veľkosť reproduktorov	Reproduktor: Ø89 mm x2
Bluetooth	Verzia: 4,0 Profil: A2DP / SCMS-T Podporovaný kódok: SBC / AAC
Rozmery	262x163x431 mm
Hmotnosť	4,3 – 4,9 kg
USB nabíjanie	áno
USB prehrávanie	nie
Dodávané s AC adaptérom	

CXT LXT Bluetooth DAB+

DMR112  
216,99 €



Aku rádio

DMR108 7,2 – 18 V / AC

NOVINKA

Li-ion



Frekvencia	FM / AM: 87,5 – 108 MHz / 522 – 1.710 kHz
Veľkosť reproduktorov	Reproduktor: Ø89 mm×2
Max. výkon	18 V: 3,5 W×2 14,4 V: 2,2 W×2 10,8 V: 1,2 W×2 7,2 V: 0,5 W×2
Bluetooth	Verzia: 4,0; Profil: A2DP / SCMS-T Podporovaný kódok: SBC Max. dosah: 10 m (33 ft)
Rozmery	262×163×431 mm
Hmotnosť	4,4 kg
USB nabíjanie	áno
USB prehrávanie	nie
Dodávané s AC adaptérom	

7.2V 18V 12V<sub>MAX</sub>

CXT LXT Bluetooth

DMR108N  
207,99 €

Aku rádio

DMR110 7,2 – 18 V / AC

NOVINKA

Li-ion



Frekvencia	FM / DAB / DAB+: 87,5 – 108 MHz / / 174,928 – 239,200 MHz / 174,928 – 239,200 MHz
Veľkosť reproduktorov	Reproduktor: Ø76 mm×2
Max. výkon	18 V: 3,5 W×2 14,4 V: 2,2 W×2 10,8 V: 1,2 W×2 7,2 V: 0,5 W×2
Rozmery	257×163×431 mm
Hmotnosť	4,1 – 4,6 kg
USB nabíjanie	áno
USB prehrávanie	nie
Dodávané s AC adaptérom	

7.2V 18V

CXT LXT DAB DAB+

DMR110N  
197,99 €

Aku rádio

DMR301

Li-ion



Frekvencia	FM / DAB / DAB+ 87,5 – 108 MHz / 174,928 – 239,200 MHz / 174,928 – 239,200 MHz
Bluetooth	4,2 verzia
Rozmery	285×185×305 mm
Hmotnosť	4,4 kg
USB nabíjanie	áno
USB prehrávanie	nie
Dodávané s AC adaptérom	

12V 18V

CXT LXT Bluetooth DAB+

DMR301  
389,99 €

Aku rádio

MR052

Li-ion



Frekvencia	FM / AM: 87,5 – 108 MHz / 522 – 1.710 kHz
Pracovný čas (hod)	s BL1041B: 30 s BL1021B: 15 s BL1016: 11
Rozmery	169×73×74 mm
Hmotnosť	0,56 – 0,72 kg

12V

CXT

MR052  
65,99 €

Aku reproduktor

DMR203

Li-ion



Veľkosť reproduktorov	Reproduktor: Ø101,6 mm Výškový reproduktor: Ø36 mm
Bluetooth	Verzia: 5,0 Profil: A2DP / SCMS-T / AVRCP Podporovaný kódok: SBC Max. dosah: 10 m
Rozmery	217×205×286 mm
Hmotnosť	2,7 – 3,4 kg

18V 14.4V 12V

CXT LXT Bluetooth

DMR203  
207,99 €

## Aku reproduktor

DMR202

Li-ion



18V

14.4V

12V

Veľkosť reproduktorov	Reproduktor: Ø101,6 mm Výškový reproduktor: Ø36 mm
Max. výkon	18 V: 10 W 14,4 V: 6 W 10,8 V: 3,5 W AC: 4 W
Bluetooth	Verzia: 4,0; Profil: A2DP / SCMS-T / AVRCP Podporovaný kódok: SBC Max. dosah: 10 m (33 ft)
Rozmery	211×206×286 mm
Hmotnosť	2,7 – 3,4 kg
USB nabíjanie	áno
USB prehrávanie	áno
Dodávané s AC adaptérom	

**CXT LXT** Bluetooth

**DMR202**  
179,99 €

## Aku &amp; elektrický vysávač

DVC150

Li-ion



18V



Objem zbernej nádoby	Prach / Voda: 15 L / 12 L
Max. prúdenie vzduchu	AC / DC: 3,6 / 2,1 m <sup>3</sup> /min
Vibrácie	2,5 m/s <sup>2</sup>
Úroveň akustického tlaku	75 dB(A)
Rozmery	366×334×421 mm
Hmotnosť	8,9 – 9,6 kg

Dodávané s hadicou, nastavkami a hubicou

**DVC150LZ**  
675,99 €

## Aku vysávač

DVC155

Li-ion



18V



Objem zbernej nádoby	Prach / Voda: 15 / 12 L
Max. prúdenie vzduchu	2,1 m <sup>3</sup> /min
Vibrácie	2,5 m/s <sup>2</sup>
Úroveň akustického tlaku	70 dB(A)
Rozmery	366×334×421 mm
Hmotnosť	7,2 – 7,9 kg

**DVC155LZX2**  
449,99 €

## Aku vysávač

DVC157

Li-ion



18V



Objem zbernej nádoby	Prach: 15
Max. prúdenie vzduchu	2,4 m <sup>3</sup> /min
Vibrácie	2,5 m/s <sup>2</sup>
Úroveň akustického tlaku	70 dB(A)
Rozmery	366×334×421 mm
Hmotnosť	8,0 – 8,6 kg

**DVC157LZX3**  
682,99 €

## Aku vysávač

DVC750

Li-ion



18V



Objem zbernej nádoby	Prach / Voda: 7,5 / 4,5 L
Pracovný čas (min.)	s BL1850B Max 30 min, Min 60 min
Max. prúdenie vzduchu	MAX 1,6 m <sup>3</sup> /min, MIN 1,3 m <sup>3</sup> /min
Vibrácie	2,5 m/s <sup>2</sup>
Úroveň akustického tlaku	76 dB(A)
Rozmery	418×251×278
Hmotnosť	4,3 – 4,6 kg

Dodávané s hadicou a nastavkami na vysávanie

**LXT BL XPT** HEPA filter  
EXTREME PROTECTION TECHNOLOGY

**DVC750LZX1**  
188,99 €

**Aku vysávač**

DVC665

**Li-ion**



18V



Objem zbernej nádoby	Prach 6,0 L
Max. prúdenie vzduchu	s hadicou 28 – 1,5: 1,8 m <sup>3</sup> /min
Vibrácie	2,5 m/s <sup>2</sup>
Úroveň akustického tlaku	70 dB(A)
Rozmery	297×174×523 mm
Hmotnosť	6,1 – 6,7 kg

Dodávané s hadicou

**DVC665ZU**  
459,99 €

**Aku vysávač**

DVC660

**Li-ion**



18V



Objem zbernej nádoby	Prach 6,0 L
Max. prúdenie vzduchu	s hadicou 32 – 1,0: 2,2 m <sup>3</sup> /min s hadicou 28 – 1,0: 2,0 m <sup>3</sup> /min
Vibrácie	2,5 m/s <sup>2</sup>
Úroveň akustického tlaku	70 dB(A)
Rozmery	297×174×523 mm
Hmotnosť	6,1 – 6,7 kg

Dodávané s hadicou, nastavcami a hubicou

**DVC660Z**  
409,99 €

**Aku vysávač**

DVC560

**Li-ion**



18V



Objem zbernej nádoby	Prach: 5 L
Max. prúdenie vzduchu	1,9 m <sup>3</sup> /min
Vibrácie	2,5 m/s <sup>2</sup>
Úroveň akustického tlaku	70 dB(A)
Rozmery	326×318×1.146 mm
Hmotnosť	8,3 – 9,0 kg

**DVC560Z**  
616,99 €

**Aku chrbtový vysávač**

DVC265

**Li-ion**



18V



Objem zbernej nádoby	Prach / Voda: 1,5 L
Pracovný čas (min.)	s BL1860B Max 40 min, Min 75 min
Max. prúdenie vzduchu	2,0 m <sup>3</sup> /min,
Vibrácie	2,5 m/s <sup>2</sup>
Úroveň akustického tlaku	70 dB(A)
Rozmery	230×152×373
Hmotnosť	3,9 – 4,5 kg

Dodávané s hadicou

**DVC265ZXU**  
378,99 €

**Aku chrbtový vysávač**

DVC261

**Li-ion**



18V



Objem zbernej nádoby	Prach / Voda: 1,5 L
Pracovný čas (min.)	s BL1860B Max 40 min, High 75 min, Normal 140 min
Max. prúdenie vzduchu	2,0 m <sup>3</sup> /min,
Vibrácie	2,5 m/s <sup>2</sup>
Úroveň akustického tlaku	70 dB(A)
Rozmery	230×152×373
Hmotnosť	3,8 – 4,5 kg

Dodávané s hadicou a nastavcami na vysávanie

**DVC261ZX11**  
363,99 €



## Aku robotický vysávač

DRC300

NOVINKA

Li-ion



Max. plocha	2 600 m <sup>2</sup> BL1860B x 2
Max. rýchlosť	0,3 m/sec
Objem zbernej nádoby	3,0 L
Rozmery	500 x 500 x 204 mm
Hmotnosť	9,6 – 10,6 kg

18V



LXT BL MOTOR

DRC300Z  
1 999,99 €

## Aku robotický vysávač

DRC200

Li-ion



Pracovný čas (min.)	s BL1850B x2: 200 s BL1830B x2: 120
Max. plocha	s BL1850B x2: 500 m <sup>2</sup> s BL1830B x2: 300 m <sup>2</sup>
Max. rýchlosť	0,3 m/sec
Objem zbernej nádoby	2,5 L
Rozmery	460x460x180 mm
Hmotnosť	7,8 kg

18V



LXT BL MOTOR

DRC200Z  
1 143,99 €

## Aku vysávač

DCL280

Li-ion



Objem zbernej nádoby	750 mL
Pracovný čas (min.)	s BL1830B: 20 min
Max. prúdenie vzduchu	1,4 m <sup>3</sup> /min
Rozmery	1.016x113x155 mm
Hmotnosť	1,2 – 1,6 kg

18V

LXT BL MOTOR

DCL280FZ  
151,99 €

## Aku vysávač

DCL180 / DCL181 / DCL182

Li-ion



	DCL180	DCL182
Objem zbernej nádoby	650 mL	Zberné vrečko: 500 mL Papierové vrečko: 330 mL
Pracovný čas (min.)	s BL1830B: 20	s BL1850B (Max.): 33 s BL1850B (Min.): 66
Max. prúdenie vzduchu	1,4 m <sup>3</sup> /min	1,4 m <sup>3</sup> /min
Rozmery	999x114x152 mm	1.004x115x151 mm
Hmotnosť	1,2 kg	1,3 kg

18V



LXT

DCL180Z  
54,99 €DCL181FZW  
67,99 €DCL182Z  
69,99 €

DCL181FZ W – v bielej farbe

## Aku vysávač

DCL184

Li-ion



Objem zbernej nádoby	500 ml
Pracovný čas (min.)	330 ml papierový sáčok Max / High / Normal: 33 / 50 / 133
Max. prúdenie vzduchu	Vysávanie: 1,4 m <sup>3</sup> /min Fúkanie: 0,8 m <sup>3</sup> /min
Rozmery	365x138x202 mm
Hmotnosť	1,8 – 2,2 kg

18V



LXT

DCL184Z  
114,99 €

**Aku vysávač**

**CL121**

**Li-ion**



12V<sub>MAX</sub>



Objem zbernej nádoby	500 mL
Max. prúdenie vzduchu	1,3 m <sup>3</sup> /min
Rozmery	345×138×202 mm
Hmotnosť	1,7 – 1,8 kg



**CL121DSA**  
216,99 €

**CL121DZ**  
114,99 €

**Aku vysávač**

**CL106FD / CL107FD**

**Li-ion**



12V<sub>MAX</sub>



CL107FD



	CL106FD	CL107FD
Objem zbernej nádoby	600 mL	Zberné vrečko: 500 mL Papierové vrečko: 330 mL
Pracovný čas (min.)	s BL1041B: 42	Max: 20 / priemer: 24 / Min: 50
Max. prúdenie vzduchu	1,3 m <sup>3</sup> /min	1,4 m <sup>3</sup> /min
Rozmery	958×100×150 mm	960×112×150 mm
Hmotnosť	1,0 kg	1,1 kg



**CL106FDWM**  
155,99 €

**CL107FDZ**  
69,99 €

**Aku vysávač**

**CL108**

**Li-ion**



12V<sub>MAX</sub>



Objem zbernej nádoby	600 mL
Pracovný čas (min.)	s BL1041B: Max/High/normal 20 / 24 / 50
Max. prúdenie vzduchu	1,3 m <sup>3</sup> /min
Rozmery	956×110×150 mm
Hmotnosť	1,0 – 1,2 kg



**CL108FDWA**  
139,99 €

**CL108FDSAP**  
151,99 €

**CL108FDZ**  
69,99 €

**Aku vysávač**

**CL114**

**Li-ion**



12V<sub>MAX</sub>



Objem zbernej nádoby	500 ml
	330 ml papierový sáčok
Pracovný čas (min.)	Max / High / Normal: 10 / 18 / 55
Max. prúdenie vzduchu	1,4 m <sup>3</sup> /min
Rozmery	983 / 457×113×136mm
Hmotnosť	1,1 kg



**CL114FDWIX**  
108,99 €

**Aku vysávač**

**CL070D**

**Li-ion**



7.2V



Objem zbernej nádoby	600 mL
Pracovný čas (min.)	8
Max. prúdenie vzduchu	1,2 m <sup>3</sup> /min
Rozmery	966×103×142 mm
Hmotnosť	0,81 kg

**CL070DS**  
97,99 €

## Aku vysávač

DCL501

Li-ion



18V



LXT



Objem zbernej nádoby	250 mL
	s BL1860B (Max.): 35
Pracovný čas (min.)	s BL1860B (Min.): 77
Max. prúdenie vzduchu	1,2 m³/min
Rozmery	352×189×252 mm
Hmotnosť	3,1 kg

Dodávané s hadicou a nastavkami na vysávanie

DCL501Z  
432,99 €

## Aku skrutkovač

DF012D

Li-ion



7.2V



Max. vrtací výkon	Železo: 5 mm
	Drevo: 6 mm
Voľnobežné otáčky	Max.: 650
	Min.: 200
Max. uťahovací moment	Tvrдый / mäkký spoj: 5,6 / 3,6 N·m
Max. povolovací moment	8,0 N·m
Vibrácie	Vrtanie do železa: 2,5 m/s²
Úroveň akustického tlaku	70 dB(A)
Rozmery	Rovná verzia: 218×44×142 mm
Rozmery (L×W)	Pistoľová verzia: 273×44 mm
Hmotnosť	0,53 kg

DF012DSE  
195,99 €

## Aku skrutkovač

TD022D

Li-ion



7.2V



Max. výkon	Skrutka so šesťhrannou hlavou: M3 – M8
	Skrutka štandardná: M3 – M8
	Skrutka vysokopevnosťná: M3 – M6
Upínanie	1/4"
Voľnobežné otáčky	0 – 2.450
Počet úderov za minútu	0 – 3.000
Max. uťahovací moment	25 N·m
Vibrácie	Upevňovacia skrutka: 7,0 m/s²
Úroveň akustického tlaku	85 dB(A)
Úroveň akustického výkonu	96 dB(A)
Rozmery	Rovná verzia: 282×42×52 mm
	Pistoľová verzia: 227×42×142 mm
Hmotnosť	0,55 – 0,56 kg

TD022DSE  
184,99 €

## Aku skrutkovač

DF001D

Li-ion



7.2V



Max. uťahovací výkon	Skrutka do dreva: ø3,8×32 mm
Voľnobežné otáčky	220
Max. uťahovací moment	Tvrдый / mäkký spoj: 4,0 / 3,0 N·m
Max. povolovací moment	6,0 N·m
Vibrácie	2,5 m/s²
Úroveň akustického tlaku	70 dB(A)
Nabíjací čas (hod.)	3 – 5
Rozmery	Rovná verzia: 287×47×51 mm
	Pistoľová verzia: 205×47×51 mm
Hmotnosť	0,36 kg

DF001DW  
65,99 €

## Aku skrutkovač s príklepom

HP488

NOVINKA

Li-ion



18V

G séria



Max. vrtací výkon	železo / drevo / murivo
	13 / 36 / 13 mm
Kapacita skľučovadla	13 mm
Počet úderov za minútu	Max / Min: 0 – 21.000 / 0 – 6.000
Voľnobežné otáčky	Max / Min: 0 – 1.400 / 0 – 400
Max. uťahovací moment	Tvrдый / mäkký spoj: 42 / 24 N·m
Rozmery	239×83×240 mm
Hmotnosť	1,7 kg

HP488D002  
149,99 €HP488DWAE  
187,99 €





18V

G séria



Max. vrtací výkon	železo / drevo
	13 / 36
Kapacita skľučovadla	13 mm
Voľnobežné otáčky	Max / Min: 0 – 1.400 / 0 – 400
Max. ťahovací moment	Tvrдый / mäkký spoj: 42 / 24 Nm
Rozmery	221×83×240 mm
Hmotnosť	1,7 kg

DF488D002  
135,99 €

DF488DWAE  
176,99 €



12V<sub>MAX</sub>



Dĺžka noža	460 mm
Počet strihov za minútu	3.600
Max. strihací výkon	18 mm
Úroveň akustického tlaku	74 dB(A)
Vibrácie	2,5 m/s <sup>2</sup>
Rozmery	1.889 – 2.511×87×134 mm
Hmotnosť	2,8 – 3,0 kg

UN460DWA  
289,99 €

UN460WDZ  
216,99 €





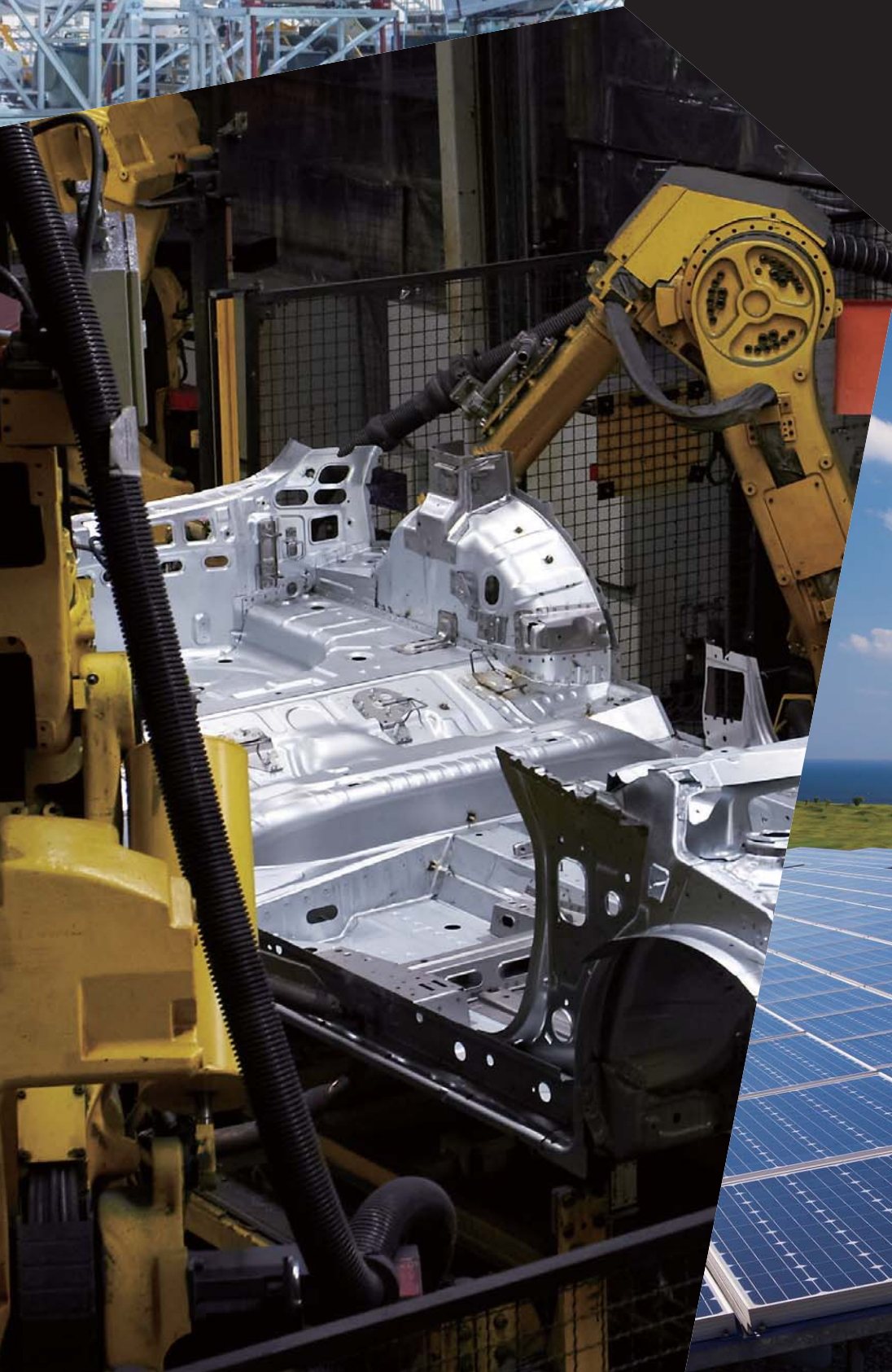



**14.4V**

## Skrutkovače, uhlové skrutkovače

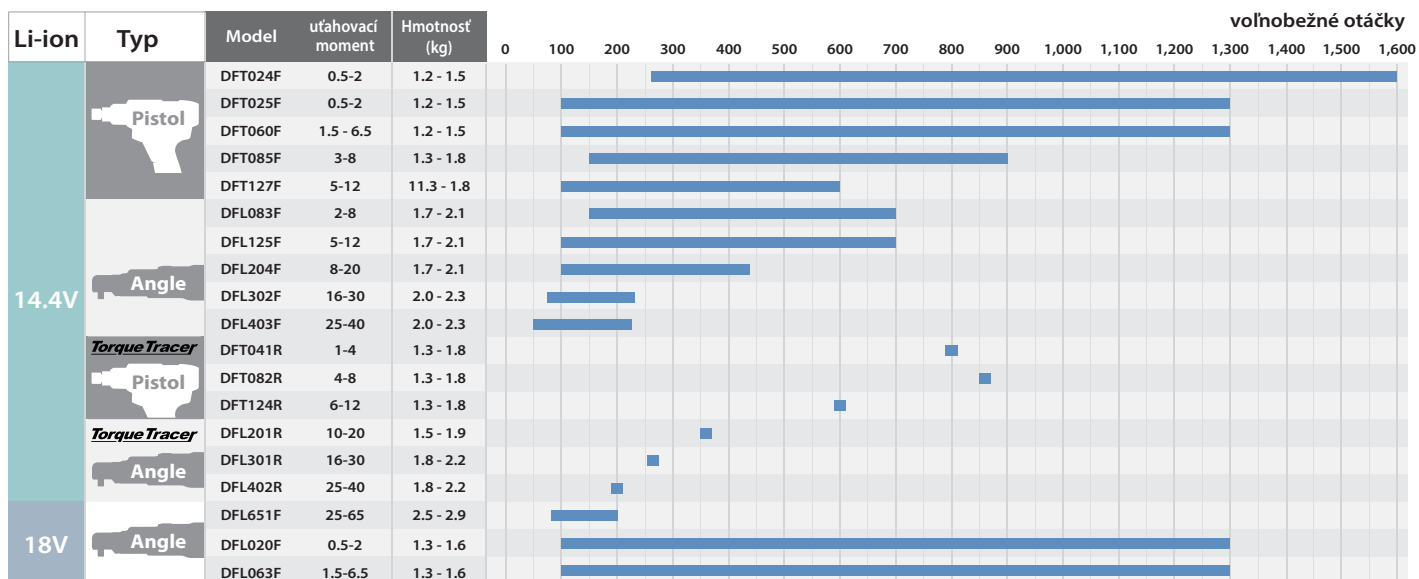

## Rázové skrutkovače/uťahovače

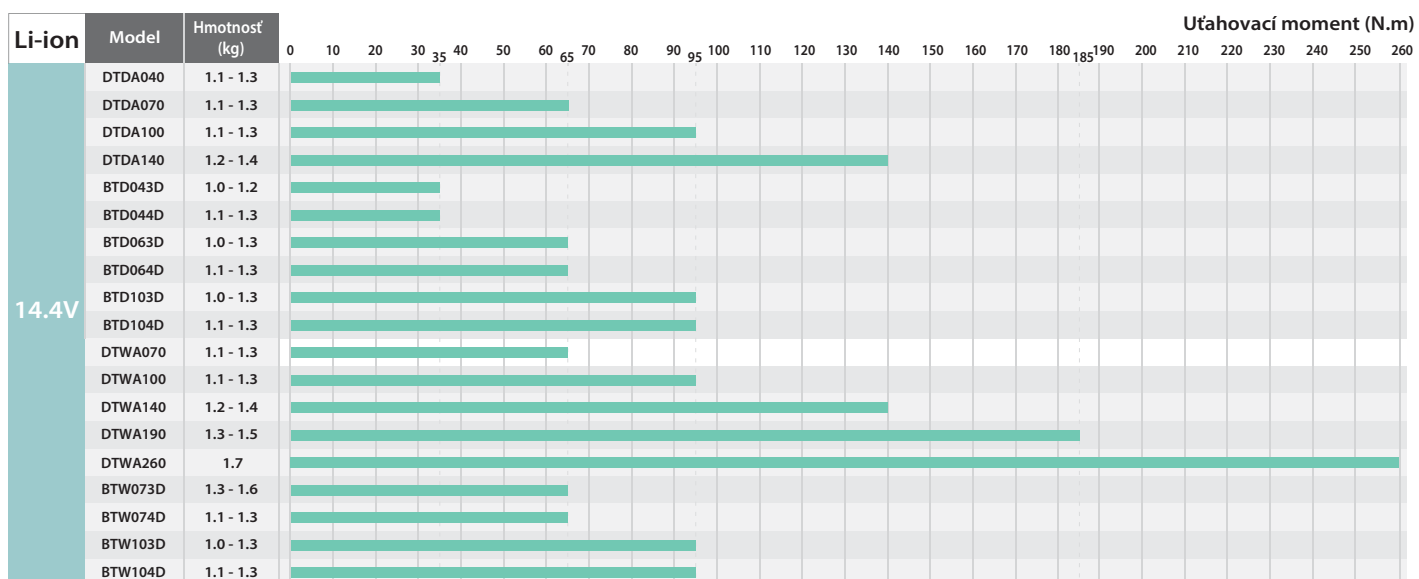



## Aku skrutkovač

DFT023F



14.4V



Upínanie	1/4"
Voľnobežné otáčky / min <sup>-1</sup>	400 – 1.300
Úťahovací moment	Tvrдый spoj / Mäkký spoj 0,5 – 2 / 0,5 – 2 N·m
Vibrácie	Úťahovanie bez príklepu: 2,5 m/s <sup>2</sup>
Úroveň akustického tlaku	70 dB(A)
Rozmery	159×72×232 mm
Hmotnosť	1,1 – 1,3 kg

**DFT023FMZ**  
 675,99 €

## Aku skrutkovač

DFT024F

NOVINKA



18V



Upínanie	1/4"
Voľnobežné otáčky / min <sup>-1</sup>	260 – 1.600
Úťahovací moment	Tvrдый spoj / Mäkký spoj 0,5 – 2 / 0,5 – 2 N·m
Rozmery	161×75×258 mm
Hmotnosť	1,2 – 1,5 kg

**DFT024FMZ**  
 707,99 €

## Aku skrutkovač

DFT025



14.4V



Upínanie	1/4"
Voľnobežné otáčky / min <sup>-1</sup>	100 – 1.300
Úťahovací moment	Tvrдый spoj / Mäkký spoj 0,5 – 2 / 0,5 – 2
Hmotnosť	1,2 – 1,5 kg

**DFT025FMZ**  
 551,99 €

## Aku skrutkovač

DFT045F



14.4V



Upínanie	1/4"
Voľnobežné otáčky / min <sup>-1</sup>	150 – 900
Úťahovací moment	Tvrдый spoj / Mäkký spoj: 1 – 4 / 1 – 4 N·m
Vibrácie	Úťahovanie bez príklepu: 2,5 m/s <sup>2</sup>
Úroveň akustického tlaku	70 dB(A)
Rozmery	159×72×232 mm
Hmotnosť	1,1 – 1,3 kg

**DFT045FZ**  
 675,99 €

## Aku skrutkovač

DFT060



14.4V



Upínanie	1/4"
Voľnobežné otáčky / min <sup>-1</sup>	100 – 1.300
Úťahovací moment	Tvrдый spoj / Mäkký spoj: 1,5 – 6,5 Nm
Rozmery	161×75×258 mm
Hmotnosť	1,2 – 1,5 kg

**DFT060FMZ**  
 551,99 €

**Aku skrutkovač**

**DFT085F**



**14.4V**



Upínanie	1/4"
Voľnobežné otáčky / min <sup>-1</sup>	150 – 900
Ťahovací moment	Tvrдый spoj / Mäkký spoj: 3 – 8 / 3 – 8 N·m (27 – 71 / 27 – 71 in.lbs.)
Vibrácie	Ťahovanie bez prilepu: 2,5 m/s <sup>2</sup>
Úroveň akustického tlaku	70 dB(A)
Rozmery	190x72x237 mm
Hmotnosť	1,3 – 1,8 kg

**DFT085FMZ**  
**707,99 €**

**Aku skrutkovač**

**DFT120T**

**NOVINKA**



**18V**



Upínanie	1/4"
Voľnobežné otáčky / min <sup>-1</sup>	50 – 700
Ťahovací moment	Tvrдый spoj / Mäkký spoj: 4 – 12 N·m
Rozmery	209 x 72 x 249 mm
Hmotnosť	1,3 – 1,6 kg

**DFT120TZ**  
**Cena na vyžiadanie**

**Aku skrutkovač**

**DFT127F**



**14.4V**



Upínanie	1/4"
Voľnobežné otáčky / min <sup>-1</sup>	100 – 600
Ťahovací moment	Tvrдый spoj / Mäkký spoj: 5 – 12 / 5 – 12 N·m
Vibrácie	Ťahovanie bez prilepu: 2,5 m/s <sup>2</sup>
Úroveň akustického tlaku	70 dB(A)
Rozmery	190x72x237 mm
Hmotnosť	1,3 – 1,8 kg

**DFT127FZ**  
**707,99 €**

**Aku skrutkovač**

**DFL302F**



**14.4V**



Upínanie	3/8"
Voľnobežné otáčky / min <sup>-1</sup>	70 – 230
Ťahovací moment	Tvrдый spoj / Mäkký spoj: 16 – 30 / 16 – 30 N·m
Rozmery	s BL1415N: 501x74x98 mm s BL1430(B) / BL1440 / BL1450 / BL1460B: 518x74x98 mm
Hmotnosť	2,0 – 2,3 kg

**DFL302FZ**  
**1 663,99 €**

**Aku skrutkovač**

**DFL063F**



**18V**

**14.4V**



Upínanie	3/8"
Voľnobežné otáčky / min <sup>-1</sup>	180 – 1.300
Ťahovací moment	Tvrдый spoj / Mäkký spoj: 1,5 – 6,5 / 1,5 – 6,5
Rozmery	397x74x116 mm
Hmotnosť	1,3 – 1,6 kg

**DFL063FZ**  
**2 079,99 €**

## Aku skrutkovač

DFL083



14.4V



Upínanie	3/8"
Voľnobežné otáčky / min <sup>-1</sup>	150 – 700
Úťahovací moment	Tvrдый spoj / Mäkký spoj: 1 2 – 8 / 2 – 8 N·m
Vibrácie	Úťahovanie bez príklepu: 2,5 m/s <sup>2</sup>
Úroveň akustického tlaku	70 dB(A)
Rozmery	480x74x98 mm
Hmotnosť	1,7 – 2,1 kg

**DFL083FZ**  
**915,99 €**

## Aku skrutkovač

DFL204



14.4V



Upínanie	3/8"
Voľnobežné otáčky / min <sup>-1</sup>	100 – 440
Úťahovací moment	Tvrдый spoj / Mäkký spoj: 8 – 20 / 8 – 20 N·m
Vibrácie	Úťahovanie bez príklepu: 2,5 m/s <sup>2</sup>
Úroveň akustického tlaku	70 dB(A)
Rozmery	480x74x98 mm
Hmotnosť	1,7 – 2,1 kg

**DFL204FZ**  
**1 663,99 €**

## Aku skrutkovač

DFL301



14.4V



Upínanie	3/8"
Voľnobežné otáčky / min <sup>-1</sup>	260
Úťahovací moment	Tvrдый spoj / Mäkký spoj: 16 – 30 / 16 – 30 N·m
Vibrácie	Úťahovanie bez príklepu: 2,5 m/s <sup>2</sup>
Úroveň akustického tlaku	74 dB(A)
Rozmery	477x72x98 mm
Hmotnosť	1,7 – 2,1 kg

**DFL301FZ**  
**1 975,99 €**

## Aku skrutkovač

DFL402



14.4V















Upínanie	3/8"
Voľnobežné otáčky / min <sup>-1</sup>	200
Úťahovací moment	Tvrдый spoj / Mäkký spoj: 25 – 40 / 25 – 40 N·m
Vibrácie	Úťahovanie bez príklepu: 2,5 m/s <sup>2</sup>
Úroveň akustického tlaku	72 dB(A)
Rozmery	477x72x98 mm
Hmotnosť	1,7 – 2,1 kg

**DFL402FZ**  
**2 079,99 €**



# ▣ VŘTANIE / UŤAHOVANIE



-  Dvojitá izolácia
-  Nastavenie otáčok
-  Brzda
-  Spätňý chod
-  Dvojrýchlostná prevodovka
-  Trojrýchlostná prevodovka
-  El. nastavenie otáčok /2 rýchlostí/
-  Rýchlosťkľučovadlo
-  Nastavenie momentu /6 stupňov/
-  Obmedzovač momentu
-  Obmedzovač rozbehového prúdu
-  Zabudované osvetlenie
-  Prepravný kufor

## Rázový skrutkovač

TD0101F

419



Príkon	230 W
Max. výkon	Skrutka so šesťhrannou hlavou: M4 – M8 Skrutka štandardná: M5 – M14 Skrutka vysokopevnosťná: M5 – M10
Upínanie	1/4"
Počet úderov za minútu	0 – 3.200
Voľnobežné otáčky	0 – 3.600
Max. ťahovací moment	100 N·m
Rozmery	184×67×192 mm
Hmotnosť	0,99 kg
Dĺžka privodného kábla	2,5 m

**TD0101F**  
**108,99 €**

## Vŕtačka

DP2010 6,5 mm

419



Príkon	370 W
Max. výkon	Železo: 6,5 mm Drevo: 15 mm
Voľnobežné otáčky	0 – 4.200
Rozmery	209×64×175 mm
Hmotnosť	1,0 kg
Dĺžka privodného kábla	2,0 m

**DP2010**  
**65,99 €**

## Vŕtačka / skrutkovač

DF0300 / HP0300 10 mm

419



Príkon	320 W
Max. vŕtací výkon	Betón 8 mm / IBA HP0300/ Železo 10 mm Drevo 28 mm
Rozsah skľučovadla	1,0 – 10 mm
Voľnobežné otáčky / min <sup>-1</sup>	Max / min 0 – 1.500 / 0 – 450
Max. ťahovací moment	Tvrdý spoj / mäkký spoj 56 / 21 Nm
Hmotnosť HP0300	1,3 kg
Hmotnosť DF0300	1,2 kg
Dĺžka privodného kábla	2,5 m

**DF0300**  
**75,99 €**
**HP0300**  
**87,99 €**

## Vŕtačka

6408 10 mm

419



Príkon	530 W
Max. výkon	Železo: 10 mm Drevo: 25 mm
Voľnobežné otáčky	0 – 2.500
Celková dĺžka	261 mm
Hmotnosť	1,5 kg
Dĺžka privodného kábla	2,5 m

**6408**  
**124,99 €**

## Vŕtačka

6413 / 6412 10 mm

64



	6413	6412
Príkon	450 W	450 W
Max. výkon	Železo: 10 mm Drevo: 25 mm	Železo: 10 mm Drevo: 25 mm
Voľnobežné otáčky	0 – 3.400	0 – 3.400
Rozmery	234×64×183 mm	228×64×183 mm
Hmotnosť	1,3 kg	1,3 kg
Dĺžka privodného kábla	2,0 m	2,0 m



6413

**6413**  
**83,99 €**
**6412**  
**75,99 €**

## Vrtačka

DP4003 13 mm

419 



Prikon	750 W
Max. výkon	Železo: 13 mm Drevo: 38 mm
Voľnobežné otáčky	0 – 700
Celková dĺžka	308 mm
Hmotnosť	2,5 kg
Dĺžka privodného kábla	2,5 m



**DP4003**  
**249,99 €**

## Vrtačka /dvojrychlostná/

DP4011 / DP4010 13 mm

419 



Prikon	720 W
Max. výkon	Železo max.: 8 mm Železo min.: 13 mm Drevo max.: 25 mm Drevo min.: 40 mm
Voľnobežné otáčky	Max.: 0 – 2.900 Min.: 0 – 1.200
Rozmery	347×70×220 mm
Hmotnosť	2,3 kg
Dĺžka privodného kábla	2,5 m



DP4011

**DP4011**  
**162,99 €**

**DP4010**  
**141,99 €**

## Vrtačka

DS4012 13 mm

411 



Prikon	750 W
Max. výkon	Železo: 13 mm Drevo: 36 mm
Voľnobežné otáčky	0 – 600
Rozmery	340×83×390 mm
Hmotnosť	2,8 kg
Dĺžka privodného kábla	2,5 m



**DS4012**  
**216,99 €**

## Uhlová vrtačka

DA3010F 10 mm

419 

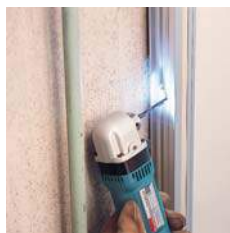

Prikon	450 W
Max. výkon	Železo: 10 mm Drevo: 25 mm
Voľnobežné otáčky	0 – 2.400
Celková dĺžka	270 mm
Hmotnosť	1,6 kg
Dĺžka privodného kábla	2,5 m



**DA3010F**  
**279,99 €**

## Uhlová vrtačka

DA4000LR 13 mm

303 



Prikon	710 W
Max. výkon	Železo: 13 mm
Voľnobežné otáčky	Max.: 0 – 900 Min.: 0 – 400
Celková dĺžka	413 mm
Hmotnosť	4 kg
Dĺžka privodného kábla	2,5 m



**DA4000LR**  
**509,99 €**



## Dimantová vrtáčka

DBM230 /mokré vrtanie/

EE7332022S 

Príkon	2.500 W
Max. výkon	Betón (s diamantovou korunkou): 230 mm
Voľnobežné otáčky	3: 1.700
	2: 1.040
	1: 390
Hmotnosť	37,5 kg

DBM230  
1 622,99 €

## Dimantová vrtáčka

DBM131 /mokré vrtanie/ / DBM130 /suché vrtanie/

EE80600306 

	DBM131	DBM130
Príkon	1.700 W	1.700 W
Max. výkon		
(s diamantovou korunkou) Max.:	Betón: 70 mm	Betón: 70 mm
(s diamantovou korunkou) Min.:	Betón: 132 mm	Betón: 132 mm
Upínanie nástroja	(Vreteno /oska/) : M18	(Vreteno /oska/) : M18
Voľnobežné otáčky	Max.: 0 – 2.300	Max.: 0 – 3.000
	Min.: 0–1.100	Min.: 0–1.500
Hmotnosť	6,3 kg	5,5 kg

DBM131  
894,99 €DBM130  
692,99 €

## Dimantová vrtáčka

DBM080 82 mm /suché vrtanie/

EE80600306 

Príkon	1.300 W
Max. výkon	Betón (s diamantovou korunkou): 82 mm
Upínanie nástroja	(Vreteno /oska/) : M18
Voľnobežné otáčky	0 – 3.400
Hmotnosť	3,4 kg

DBM080  
415,99 €

## Miešadlo

UT1600 / UT1401

EE7132A22S  EE7332022S 

	UT1600	UT1401
Príkon	1.800 W	1.300 W
Max. hmotnosť hmoty	90 kg	60 kg
Max. priemer miešadla	180 mm	140 mm
Voľnobežné otáčky	Max. / Min.: 0 – 970 / 0 – 440	Max. / Min.: 0 – 730 / 0 – 400
Rozmery	430×180×349 mm	430×180×349 mm
Hmotnosť	7,1 kg	5,5 kg
Dĺžka privodného kábla	3,2 m	3,2 m

UT1600  
486,99 €UT1401  
357,99 €

## Miešadlo

UT1400 140 mm

EE7132A22S 

Príkon	1.300 W
Max. hmotnosť hmoty	50 kg
Max. priemer miešadla	140 mm
Voľnobežné otáčky	0 – 900
Rozmery	430×180×305 mm
Hmotnosť	5,2 kg
Dĺžka privodného kábla	3,2 m

UT1400  
324,99 €

Miešadlo

UT1200 120 mm

EE77018225 



Prikon	960 W
Max. hmotnosť hmoty	40 kg
Max. priemer miešadla	120 mm
Voľnobežné otáčky	0 – 590
Rozmery	345×180×295 mm
Hmotnosť	3,2 kg
Dĺžka privodného kábla	3,2 m



**UT1200**  
216,99 €

Miešadlo

UT2204 / UT1305

303 



	UT2204	UT1305
Prikon	850 W	850 W
Max. priemer miešadla	220 mm	165 mm
Voľnobežné otáčky	550	1.300
Upínanie nástroja	M12 alebo M14	M12
Rozmery	929×89×152 mm	942×87×152 mm
Hmotnosť	2,7 kg	2,6 kg
Dĺžka privodného kábla	2,5 m	2,5 m



**UT2204**  
259,99 €

**UT1305**  
253,99 €

Skrutkovač na sadrokartón

FS2300

419 



Prikon	570 W
Max. výkon	Sadrokartónové skrutky: 5 mm Samozávrtné skrutky: 6 mm
Upínanie	1/4"
Voľnobežné otáčky	0 – 2.500
Vibrácie	2,5 m/s <sup>2</sup>
Úroveň akustického tlaku	83 dB(A)
Úroveň akustického výkonu	94 dB(A)
Rozmery	290×70×207 mm
Hmotnosť	1,6 kg
Dĺžka privodného kábla	2,5 m



**FS2300**  
155,99 €

Skrutkovač na sadrokartón

FS4000

419 



Prikon	570 W
Max. výkon	Sadrokartónové skrutky: 5 mm Samozávrtné skrutky: 6 mm
Upínanie	1/4"
Voľnobežné otáčky	0 – 4.000
Vibrácie	2,5 m/s <sup>2</sup>
Úroveň akustického tlaku	82 dB(A)
Úroveň akustického výkonu	93 dB(A)
Rozmery	269×65×207 mm
Hmotnosť	1,3 kg
Dĺžka privodného kábla	2,5 m



**FS4000**  
103,99 €

Skrutkovač na sadrokartón

FS4300

419 

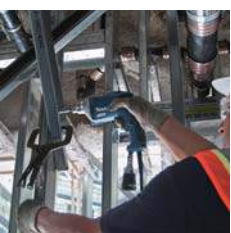

Prikon	570 W
Max. výkon	Sadrokartónové skrutky: 5 mm Samozávrtné skrutky: 6 mm
Upínanie	1/4"
Voľnobežné otáčky	0 – 4.000
Vibrácie	2,5 m/s <sup>2</sup>
Úroveň akustického tlaku	82 dB(A)
Úroveň akustického výkonu	93 dB(A)
Rozmery	279×65×207 mm
Hmotnosť	1,4 kg
Dĺžka privodného kábla	2,5 m

X2 – podávací adaptér



**FS4300**  
145,99 €

**FS4300X2**  
187,99 €

## Skrutkovač na sadrokartón

FS6300R

419 

Príkon	570 W
Max. výkon	Sadrokartónové skrutky: 4 mm
Upínanie	1/4"
Voľnobežné otáčky	0 – 6.000
Rozmery	279×65×207 mm
Hmotnosť	1,4 kg
Dĺžka prívodného kábla	4,0 m

**FS6300R**  
**135,99 €**

## Skrutkovač

FS2700

419 

Príkon	570 W
Max. výkon	Samozávrtné skrutky: 6 mm
	Skrutka so šesťhrannou hlavou: 8 mm
	Skrutky do dreva: 6,2 mm
Upínanie	1/4"
Voľnobežné otáčky	0 – 2.500
Vibrácie	2,5 m/s <sup>2</sup>
Úroveň akustického tlaku	83 dB(A)
Úroveň akustického výkonu	94 dB(A)
Rozmery	301×70×207 mm
Hmotnosť	1,8 kg
Dĺžka prívodného kábla	2,5 m

**FS2700**  
**155,99 €**

## Rázový uťahovač

TW0350 1/2"

325 

Príkon	400 W
Max. uťahovací výkon	Skrutka štandardná: M12 – M22
	Skrutka vysokopevnostná: M12 – M16
Uchytenie nástroja	1/2"
Voľnobežné otáčky	2.000
Počet úderov za minútu	2.000
Max. uťahovací moment	350 N·m
Vibrácie	11,5 m/s <sup>2</sup>
Úroveň akustického tlaku	93 dB(A)
Úroveň akustického výkonu	104 dB(A)
Rozmery	283×87×233 mm
Hmotnosť	3 kg
Dĺžka prívodného kábla	2,5 m

**TW0350**  
**291,99 €**

## Rázový uťahovač

TW0200 1/2"

415 

Príkon	380 W
Max. uťahovací výkon	Skrutka štandardná: M10 – M16
	Skrutka vysokopevnostná: M10 – M12
Uchytenie nástroja	1/2"
Voľnobežné otáčky	0 – 2.200
Počet úderov za minútu	0 – 2.200
Max. uťahovací moment	200 N·m
Vibrácie	8,5 m/s <sup>2</sup>
Úroveň akustického tlaku	93 dB(A)
Úroveň akustického výkonu	104 dB(A)
Rozmery	251×72×220 mm
Hmotnosť	2,1 kg
Dĺžka prívodného kábla	2,5 m

**TW0200**  
**259,99 €**

## Rázový uťahovač

TW1000 1"

153 

Príkon	1.200 W
Max. uťahovací výkon	Skrutka štandardná: M24 – M30
	Skrutka vysokopevnostná: M22 – M24
Uchytenie nástroja	1"
Voľnobežné otáčky	1.400
Počet úderov za minútu	1.500
Max. uťahovací moment	1.000 N·m
Vibrácie	17,5 m/s <sup>2</sup>
Úroveň akustického tlaku	103 dB(A)
Úroveň akustického výkonu	114 dB(A)
Rozmery	382×110×290 mm
Hmotnosť	8,8 kg
Dĺžka prívodného kábla	2,5 m

**TW1000**  
**894,99 €**





















Model	Volnobežné otáčky	Počet rýchlostí	Max. ťahovací model (Nm)	Celková dĺžka (mm)	Hmotnosť (kg)	BL motor
<b>Akumulátorový rázový skrutkovač</b>						
TD001G	0 – 3.700 / 3.200 / 2.100 / 1.100	4-Speed	220	120	1,7 – 2,0 kg (3,7 – 4,4 lbs.)	●
DTD172	0 – 3.600 / 3.200 / 2.100 / 1.100	4-Speed	180	114	1,2 – 1,5 kg (2,6 – 3,3 lbs.)	●
DTD154	0 – 3.600 / 2.100 / 1.100	3-Speed	175	117	1,3 – 1,6 kg (2,7 – 3,4 lbs.)	●
DTD153	0 – 3.400	–	170	126	1,3 – 1,6 kg (2,8 – 3,5 lbs.)	●
DTD157	0 – 3.000 / 1.300	2-Speed	140	133	1,2 – 1,5 kg (2,6 – 3,3 lbs.)	●
DTD152	0 – 2.900	–	165	137	1,3 – 1,6 kg (2,8 – 3,5 lbs.)	–
DTD156	0 – 2.500	–	155	143	1,3 – 1,6 kg (2,9 – 3,6 lbs.)	–
TD111D	0 – 3.000 / 1.300	2-Speed	135	135	0,97 – 1,1 kg (2,1 – 2,5 lbs.)	●
TD110D	0 – 2.600	–	110	153	1 – 1,2 kg (2,3 – 2,6 lbs.)	–
TD090D	0 – 2.400	–	90	155	0,92 kg (2 lbs.)	–
TD022D	0 – 2.450	–	25	227	0,55 – 0,56 kg (1,2 lbs.)	–
TD127D	0 – 2.300	–	140	173	1,5 kg (3,2 lbs.)	–
TD126D	0 – 2.400	–	135	173	1,4 kg (3,1 lbs.)	–

Model	Square drive	Max. ťahovací model (Nm)	Volnobežné otáčky	Celková dĺžka (mm)	Hmotnosť (kg)	BL motor
<b>Akumulátorový rázový ťahač</b>						
TW001G	3/4" (19 mm)	1.800	0 – 1.800 / 1.400 / 1.150 / 950	217	3,9 – 4,2 kg (8,6 – 9,3 lbs.)	●
TW007G	1/2" (12,7 mm)	760	0 – 2.300 / 1.900 / 1.200 / 600	170	2,7 – 3,3 kg (6,0 – 7,3 lbs.)	●
TW008G	1/2" (12,7 mm)	760	0 – 2.300 / 1.900 / 1.200 / 600	170	2,7 – 3,3 kg (6,0 – 7,3 lbs.)	●
TW004G	1/2" (12,7 mm)	350	0 – 3.200 / 2.600 / 1.800 / 1.000	144	1,9 – 2,2 kg (4,2 – 4,9 lbs.)	●
TW005G	1/2" (12,7 mm)	350	0 – 3.200 / 2.600 / 1.800 / 1.000	144	1,9 – 2,2 kg (4,2 – 4,9 lbs.)	●
DTW1001	3/4" (19mm)	1.050	0 – 1.800 / 1.000 / 900	229	3,4 – 3,7 kg (7,5 – 8,2 lbs.)	●
DTW1002	1/2" (12,7mm)	1.000	0 – 1.800 / 1.000 / 900	229	3,3 – 3,6 kg (7,3 – 8,0 lbs.)	●
DTW800	7/16" (11,2mm) Hex,	800	0 – 1.800 / 1.000 / 900	229	3,4 – 3,7 kg (8,2 – 7,5 lbs.)	●
DTW700	1/2" (12,7mm)	700	0 – 2.200 / 1.900 / 1.200 / 500	170	2,3 – 2,7 kg (5,1 – 6,0 lbs.)	●
DTW701	1/2" (12,7mm)	700	0 – 2.200 / 1.900 / 1.200 / 500	170	2,3 – 2,7 kg (5,1 – 6,0 lbs.)	●
DTW450	1/2" (12,7mm)	440	1.600	266	3,1 – 3,4 kg (7,6 – 6,9 lbs.)	–
DTW300	1/2" (12,7mm)	330	0 – 3.200 / 2.600 / 1.800 / 1.000	144	1,5 – 1,8 kg (3,4 – 4,1 lbs.)	●
DTW301	1/2" (12,7mm)	330	0 – 3.200 / 2.600 / 1.800 / 1.000	144	1,5 – 1,8 kg (3,4 – 4,1 lbs.)	●
DTW302	3/8" (9,5 mm)	300	0 – 3.200 / 2.600 / 1.800 / 1.000	138	1,4 – 1,8 kg (3,1 – 4,0 lbs.)	●
DTW251	1/2" (12,7mm)	230	0 – 2.100	165	1,5 – 1,8 kg (3,2 – 3,9 lbs.)	–
DTW253	3/8" (9,5mm)	210	0 – 2.100	155	1,3 – 1,6 kg (2,8 – 3,6 lbs.)	–
DTW181	1/2" (12,7mm)	210	0 – 2.400 / 1.300	151	1,2 – 1,5 kg (2,7 – 3,4 lbs.)	●
DTW190	1/2" (12,7mm)	190	0 – 2.300	176	1,4 – 1,8 kg (3,2 – 3,9 lbs.)	–
DTW180	3/8" (9,5mm)	180	0 – 2.400 / 1.300	144	1,2 – 1,5 kg (2,7 – 3,4 lbs.)	●
TW161D	1/2" (12,7 mm)	165	0 – 2.400 / 1.300	150	1,1 – 1,2 kg (2,4 – 2,7 lbs.)	●
TW160D	3/8" (9,5 mm)	160	0 – 2.400 / 1.300	144	1,0 – 1,2 kg (2,2 – 2,6 lbs.)	●
TW141D	1/2" (12,7 mm)	145	0 – 2.600	168	1,1 – 1,2 kg (2,4 – 2,7 lbs.)	–
TW140D	3/8" (9,5 mm)	140	0 – 2.600	161	1,0 – 1,2 kg (2,3 – 2,7 lbs.)	–
TW060D	1/4" (6,35 mm)	60	0 – 2.600	161	1,0 – 1,2 kg (2,2 – 2,6 lbs.)	–
TW100D	3/8" (9,5 mm)	110	0 – 2 300	163	0,95 kg (2,1 lbs.)	–

# ▣ VŔTANIE S PRÍKLEPOM / BÚRANIE



-  Dvojitá izolácia
-  Nastavenie otáčok
-  Spätný chod
-  Rýchlosklučovadlo
-  Zabudované osvetlenie
-  Dvojrýchlostná prevodovka
-  Obmedzovač momentu
-  Konštantné otáčky
-  Obmedzovač rozbehového prúdu
-  SDS Plus
-  SDS Max
-  17 mm Hex
-  19 mm Hex
-  21 mm Hex
-  28,6 mm Hex
-  30 mm Hex
-  Klinový hriadeľ
-  Odsávanie prachu
-  Prepravný kufor

## Vrtačka s príklepom

HP1631K / HP1630K 16 mm

85



HP1631K



Príkon	710 W
Max. výkon	Betón: 16 mm Železo: 13 mm Drevo: 30 mm
Voľnobežné otáčky	0 – 3.200
Počet úderov za minútu	0 – 48.000
Vibrácie	Vrtanie s príklepom: 17,0 m/s <sup>2</sup> Vrtanie do železa: 2,5 m/s <sup>2</sup>
Úroveň akustického tlaku	97 dB(A)
Úroveň akustického výkonu	108 dB(A)
Rozmery	296×75×204 mm
Hmotnosť	HP1631 : 2,0 kg HP1630 : 2,1 kg
Dĺžka privodného kábla	2,0 m

**HP1631K**  
108,99 €

**HP1630K**  
97,99 €

## Vrtačka s príklepom

HP1641 16 mm

419



Príkon	680 W
Max. výkon	Betón: 16 mm Železo: 13 mm Drevo: 30 mm
Voľnobežné otáčky	0 – 2.800
Počet úderov za minútu	0 – 44.800
Vibrácie	Vrtanie s príklepom: 19 m/s <sup>2</sup> Vrtanie do železa: 2,5 m/s <sup>2</sup>
Úroveň akustického tlaku	92 dB(A)
Úroveň akustického výkonu	103 dB(A)
Rozmery	303×72×222 mm
Hmotnosť	2,0 kg
Dĺžka privodného kábla	2,0 m

**HP1641K1X**  
108,99 €

1X – 9 dielna sada vrtákov

## Vrtačka s príklepom

HP1640K 16 mm

419



Príkon	680 W
Max. výkon	Betón: 16 mm Železo: 13 mm Drevo: 30 mm
Voľnobežné otáčky	0 – 2.800
Počet úderov za minútu	0 – 44.800
Vibrácie	Vrtanie s príklepom: 19 m/s <sup>2</sup> Vrtanie do železa: 2,5 m/s <sup>2</sup>
Úroveň akustického tlaku	92 dB(A)
Úroveň akustického výkonu	103 dB(A)
Rozmery	303×72×222 mm
Hmotnosť	2,0 kg
Dĺžka privodného kábla	2,0 m

**HP1640K**  
87,99 €

## Dvojrýchlostná vrtačka s príklepom

HP2071J 20 mm

419



Príkon	1.010 W
Max. výkon	Betón: 20 mm Železo max.: 8 mm Železo min.: 16 mm Drevo max.: 25 mm Drevo min.: 40 mm
Počet úderov za minútu	Max.: 0 – 58.000 Min.: 0 – 24.000
Voľnobežné otáčky	Max.: 0 – 2.900 Min.: 0 – 1.200
Celková dĺžka	362 mm
Hmotnosť	2,6 kg
Dĺžka privodného kábla	2,5 m

**HP2071J**  
238,99 €

## Dvojrýchlostná vrtačka s príklepom

HP2070J 20 mm

419



Príkon	1.010 W
Max. výkon	Betón: 20 mm Železo max.: 8 mm Železo min.: 16 mm Drevo max.: 25 mm Drevo min.: 40 mm
Počet úderov za minútu	Max.: 0 – 58.000 Min.: 0 – 24.000
Voľnobežné otáčky	Max.: 0 – 2.900 Min.: 0 – 1.200
Celková dĺžka	364 mm
Hmotnosť	2,6 kg
Dĺžka privodného kábla	2,5 m

**HP2070J**  
227,99 €



## Dvojrýchlostná vrtačka s príklepom HP2051HJ 20 mm

419 

Príkon	720 W
Max. výkon	Betón: 20 mm Železo max.: 8 mm Železo min.: 13 mm Drevo max.: 25 mm Drevo min.: 40 mm
Počet úderov za minútu	Max.: 0 – 58.000 Min.: 0 – 24.000
Voľnobežné otáčky	Max.: 0 – 2.900 Min.: 0 – 1.200
Celková dĺžka	360 mm
Hmotnosť	2,5 kg
Dĺžka privodného kábla	2,5 m

**HP2051HJ**  
**173,99 €**

## Dvojrýchlostná vrtačka s príklepom HP2050HJ 20 mm

419 

Príkon	720 W
Max. výkon	Betón: 20 mm Železo max.: 8 mm Železo min.: 13 mm Drevo max.: 25 mm Drevo min.: 40 mm
Počet úderov za minútu	Max.: 0 – 58.000 Min.: 0 – 24.000
Voľnobežné otáčky	Max.: 0 – 2.900 Min.: 0 – 1.200
Celková dĺžka	362 mm
Hmotnosť	2,5 kg
Dĺžka privodného kábla	2,5 m

**HP2050HJ**  
**151,99 €**

## Magnetická vrtačka

HB350

NOVINKA

459 

Príkon	1 050 B701W
Max. vrtací výkon	35 mm
Voľnobežné otáčky	850 / min
Magnetická upínacia sila	8.000 N
Rozmery	270x110x330 mm
Hmotnosť	11,5 kg

**HB350**  
**746,99 €**

## Vrtacie kladivo s príklepom HR1840 18 mm, SDS-PLUS

459 

Príkon	470 W
Síla príklepu	EPTA-Procedure 05/2009: 1,6 J
Max. výkon	Betón: 18 mm Vrtacia korunka: 35 mm Diamantová vrtacia korunka: 65 mm Železo: 13 mm Drevo: 24 mm
Počet úderov / min <sup>-1</sup>	0 – 4.800
Voľnobežné otáčky	0 – 2.100
Úroveň akustického tlaku	87 dB(A)
Úroveň akustického výkonu	98 dB(A)
Vibrácie	Vrtanie s príklepom: 10,0 m/s <sup>2</sup>
Rozmery	285x75x208 mm
Hmotnosť	2,0 – 2,4 kg

**HR1840**  
**129,99 €**

## Vrtacie kladivo s príklepom HR2300 23 mm, SDS-PLUS

325 

Príkon	720 W
Síla príklepu	EPTA-Procedure 05/2009: 2,3 J
Max. výkon	Betón: 23 mm Železo: 13 mm Drevo: 32 mm
Počet úderov / min <sup>-1</sup>	0 – 4.600
Voľnobežné otáčky	0 – 1.200
Úroveň akustického tlaku	90 dB(A)
Úroveň akustického výkonu	101 dB(A)
Vibrácie	Vrtanie s príklepom: 15,5 m/s <sup>2</sup>
Rozmery	356x77x209 mm
Hmotnosť	2,7 – 3,1 kg
Dĺžka privodného kábla	2,5 m

**HR2300**  
**162,99 €**

## Kombinované kladivo

HR2470T 24 mm, SDS-PLUS

325



Rýchloskľučovadlo



Prikon	780 W
Sila príklepu	EPTA-Procedure 05/2009: 2,4 J
Max. výkon	Betón: 24 mm Železo: 13 mm Drevo: 32 mm
Počet úderov / min <sup>-1</sup>	0 – 4.500
Voľnobežné otáčky	0 – 1.100
Úroveň akustického tlaku	90 dB(A)
Úroveň akustického výkonu	101 dB(A)
Vibrácie	Vrtanie s príklepom: 15,5 m/s <sup>2</sup> Vrtanie do železa: 4,5 m/s <sup>2</sup>
Rozmery	394x84x214 mm
Hmotnosť	3,0 – 3,3 kg

**HR2470T**  
216,99 €

**HR2470**  
173,99 €

**HR2470BX40**  
184,99 €

B – čierne prevedenie stroja; X40 – 5 ks vrtákov SDS Plus

## Kombinované kladivo

HR2652 26 mm, SDS-PLUS

419



Prikon	800 W
Sila príklepu	EPTA-Procedure 05/2009: 2,2 J
Max. výkon	Betón: 26 mm Železo: 13 mm Drevo: 32 mm
Počet úderov / min <sup>-1</sup>	0 – 4.600
Voľnobežné otáčky / min <sup>-1</sup>	0 – 1.200
Úroveň akustického tlaku	91 dB(A)
Úroveň akustického výkonu	102 dB(A)
Vibrácie	Vrtanie s príklepom: 12,5 m/s <sup>2</sup> Vrtanie do železa: 2,5 m/s <sup>2</sup>
Rozmery	604x89x260 mm
Hmotnosť	3 – 4,3 kg
Dĺžka privodného kábla	2,5 m

**HR2652**  
329,99 €

## Kombinované kladivo

HR2641 26 mm, SDS-PLUS

419



Prikon	800 W
Sila príklepu	EPTA-Procedure 05/2009: 2,4 J
Max. výkon	Betón: 26 mm Železo: 13 mm Drevo: 32 mm
Počet úderov / min <sup>-1</sup>	0 – 4.500
Voľnobežné otáčky	0 – 1.100
Úroveň akustického tlaku	90 dB(A)
Úroveň akustického výkonu	101 dB(A)
Vibrácie	Vrtanie s príklepom: 11,5 m/s <sup>2</sup> Sekanie s rukoväťou: 9,0 m/s <sup>2</sup> Vrtanie do železa: 2,5 m/s <sup>2</sup>
Rozmery	422x76x156 mm
Hmotnosť	3,1 – 3,5 kg

**HR2641**  
207,99 €

## Kombinované kladivo

HR2631FT 26 mm, SDS-PLUS

325



Rýchloskľučovadlo

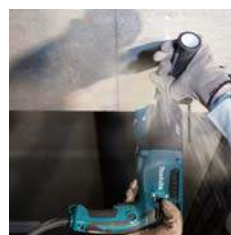

Prikon	800 W
Sila príklepu	EPTA-Procedure 05/2009: 2,4 J
Max. výkon	Betón: 26 mm Vrtacia korunka: 68 mm Diamantová vrtacia korunka: 80 mm Železo: 13 mm Drevo: 32 mm
Počet úderov / min <sup>-1</sup>	0 – 4.600
Voľnobežné otáčky	0 – 1.200
Úroveň akustického tlaku	90 dB(A)
Úroveň akustického výkonu	101 dB(A)
Vibrácie	Vrtanie s príklepom: 11,5 m/s <sup>2</sup>
Rozmery	385x77x209 mm
Hmotnosť	3,1 – 3,6 kg

**HR2631FT**  
259,99 €

**HR2631F**  
195,99 €

## Kombinované kladivo

HR2630T 26 mm, SDS-PLUS

325



Rýchloskľučovadlo



Prikon	800 W
Sila príklepu	EPTA-Procedure 05/2009: 2,4 J
Max. výkon	Betón: 26 mm Vrtacia korunka: 68 mm Diamantová vrtacia korunka: 80 mm Železo: 13 mm Drevo: 32 mm
Počet úderov / min <sup>-1</sup>	0 – 4.600
Voľnobežné otáčky	0 – 1.200
Úroveň akustického tlaku	90 dB(A)
Úroveň akustického výkonu	101 dB(A)
Vibrácie	Vrtanie s príklepom: 15,0 m/s <sup>2</sup>
Rozmery	385x77x209 mm
Hmotnosť	3,0 – 3,5 kg

**HR2630T**  
238,99 €

**HR2630**  
184,99 €

**HR2630X7**  
205,99 €

X7 – skľučovadlo

**AVT**  
ANTI VIBRATION TECHNOLOGY

**AVT**  
ANTI VIBRATION TECHNOLOGY

## Vrtacie kladivo

HR2600 28 mm, SDS-PLUS

325 

Príkon	800 W
Síla príklepu	EPTA-Procedure 05/2009: 2,4 J
Max. vrtací výkon	Betón: 26 mm
	Železo: 13 mm
	Drevo: 32 mm
Počet úderov / min <sup>-1</sup>	0 – 4.600
Voľnobežné otáčky	0 – 1.200
Úroveň akustického tlaku	91 dB(A)
Úroveň akustického výkonu	102 dB(A)
Vibrácie	Vrtanie s príklepom do betónu: 15,5 m/s <sup>2</sup>
	Vrtanie do železa: 2,5 m/s <sup>2</sup>
Rozmery	361×77×209 mm
Hmotnosť	3,0 – 3,4 kg
Dĺžka privodného kábla	2,5 m

**HR2600**  
**173,99 €**

## Kombinované kladivo

HR2811FT 28 mm, SDS-PLUS

325 

Rýchlosklúčovadlo



Príkon	800 W
Síla príklepu	EPTA-Procedure 05/2009: 2,9 J
Max. vrtací výkon	Betón: 28 mm
	Železo: 13 mm
	Drevo: 32 mm
Počet úderov / min <sup>-1</sup>	0 – 4.500
Voľnobežné otáčky	0 – 1.100
Úroveň akustického tlaku	90 dB(A)
Úroveň akustického výkonu	101 dB(A)
Vibrácie	Vrtanie s príklepom do betónu: 15,0 m/s <sup>2</sup>
	Vrtanie do železa: 2,5 m/s <sup>2</sup>
Rozmery	345×89×225 mm
Hmotnosť	3,6 – 3,9 kg
Dĺžka privodného kábla	2,5 m

**HR2811FT**  
**415,99 €**

## Kombinované kladivo

HR2810T 28 mm, SDS-PLUS

325 

Rýchlosklúčovadlo



Príkon	800 W
Síla príklepu	EPTA-Procedure 05/2009: 2,9 J
Max. vrtací výkon	Betón: 28 mm
	Železo: 13 mm
	Drevo: 32 mm
Počet úderov / min <sup>-1</sup>	0 – 4.500
Voľnobežné otáčky	0 – 1.100
Úroveň akustického tlaku	89 dB(A)
Úroveň akustického výkonu	100 dB(A)
Vibrácie	Vrtanie s príklepom do betónu: 20 m/s <sup>2</sup>
	Vrtanie do železa: 2,5 m/s <sup>2</sup>
Rozmery	339×89×225 mm
Hmotnosť	3,5 – 3,8 kg
Dĺžka privodného kábla	2,5 m

**HR2810T**  
**395,99 €**

## Kombinované kladivo

HR2810 28 mm, SDS-PLUS

325 

Príkon	800 W
Síla príklepu	EPTA-Procedure 05/2009: 2,8 J
Max. vrtací výkon	Betón: 28 mm
	Železo: 13 mm
	Drevo: 32 mm
Počet úderov / min <sup>-1</sup>	0 – 4.500
Voľnobežné otáčky	0 – 1.100
Úroveň akustického tlaku	89 dB(A)
Úroveň akustického výkonu	100 dB(A)
Vibrácie	Vrtanie s príklepom do betónu: 20 m/s <sup>2</sup>
	Vrtanie do železa: 2,5 m/s <sup>2</sup>
Rozmery	314×89×225 mm
Hmotnosť	3,4 – 3,8 kg
Dĺžka privodného kábla	2,5 m

**HR2810**  
**332,99 €**

## Vrtacie kladivo

HR2800 28 mm, SDS-PLUS

325 

Príkon	800 W
Síla príklepu	EPTA-Procedure 05/2009: 2,8 J
Max. vrtací výkon	Betón: 28 mm
	Železo: 13 mm
	Drevo: 32 mm
Počet úderov / min <sup>-1</sup>	0 – 4.500
Voľnobežné otáčky	0 – 1.100
Úroveň akustického tlaku	89 dB(A)
Úroveň akustického výkonu	100 dB(A)
Vibrácie	Vrtanie s príklepom do betónu: 20 m/s <sup>2</sup>
	Vrtanie do železa: 2,5 m/s <sup>2</sup>
Rozmery	314×89×225 mm
Hmotnosť	3,4 – 3,8 kg
Dĺžka privodného kábla	2,5 m

**HR2800**  
**311,99 €**





Prikon	1.050 W
Sila príklepu	EPTA-Procedure 05/2009: 3.9 J
Max. vrtací výkon	Betón: 30 mm
	Železo: 13 mm
	Drevo: 32 mm
Počet úderov / min <sup>-1</sup>	0 – 4.500
Voľnobežné otáčky	0 – 840
Úroveň akustického tlaku	94 dB(A)
Úroveň akustického výkonu	105 dB(A)
Vibrácie	Vrtanie do betónu 13,5 m/s <sup>2</sup>
Rozmery	369×98×226 mm
Hmotnosť	4,1 – 4,5 kg
Dĺžka privodného kábla	2,5 m

**HR3001CJ**  
**378,99 €**



Prikon	1.050 W
Sila príklepu	EPTA-Procedure 05/2009: 3.9 J
Max. vrtací výkon	Betón: 30 mm
	Železo: 13 mm
	Drevo: 32 mm
Počet úderov / min <sup>-1</sup>	0 – 4.500
Voľnobežné otáčky	0 – 840
Úroveň akustického tlaku	94 dB(A)
Úroveň akustického výkonu	105 dB(A)
Vibrácie	Vrtanie do betónu 9,5 m/s <sup>2</sup>
Rozmery	369×98×242 mm
Hmotnosť	4,4 – 4,8 kg
Dĺžka privodného kábla	2,5 m

**HR3011FCJ**  
**399,99 €**



Rýchlosklučovadlo



Prikon	1.050 W
Sila príklepu	EPTA-Procedure 05/2009: 3.9 J
Max. vrtací výkon	Betón: 30 mm
	Železo: 13 mm
	Drevo: 32 mm
Počet úderov / min <sup>-1</sup>	0 – 4.500
Voľnobežné otáčky	0 – 840
Úroveň akustického tlaku	94 dB(A)
Úroveň akustického výkonu	104 dB(A)
Vibrácie	Vrtanie do betónu 9,5 m/s <sup>2</sup>
Rozmery	369×98×242 mm
Hmotnosť	4,5 – 4,7 kg
Dĺžka privodného kábla	2,5 m

**HR3012FCWJ**  
**571,99 €**



Rýchlosklučovadlo



Prikon	850 W
Sila príklepu	EPTA-Procedure 05/2009: 4,9 J
Max. vrtací výkon	Betón: 32 mm
	Železo: 13 mm
	Drevo: 32 mm
	Vrtanie s korunkou: 90 mm
Počet úderov / min <sup>-1</sup>	1.650 – 3.300
Voľnobežné otáčky	315 – 630
Úroveň akustického tlaku	88 dB(A)
Úroveň akustického výkonu	99 dB(A)
Vibrácie	Vrtanie s príklepom do betónu: 10,0 m/s <sup>2</sup>
	Vrtanie do železa: 2,5 m/s <sup>2</sup>
Rozmery	424×114×239 mm
Hmotnosť	5,4 – 5,6 kg

**HR3210FCT**  
**831,99 €**

**HR3210C**  
**616,99 €**



Prikon	850 W
Sila príklepu	EPTA-Procedure 05/2009: 5,1 J
Max. vrtací výkon	Betón: 32 mm
	Železo: 13 mm
	Drevo: 32 mm
Počet úderov / min <sup>-1</sup>	1.650 – 3.300
Voľnobežné otáčky	315 – 630
Úroveň akustického tlaku	89 dB(A)
Úroveň akustického výkonu	100 dB(A)
Vibrácie	Vrtanie s príklepom do betónu: 18,0 m/s <sup>2</sup>
	Vrtanie do železa: 2,5 m/s <sup>2</sup>
Rozmery	398×108×239 mm
Hmotnosť	4,8 – 5,2 kg
Dĺžka privodného kábla	5,0 m

**HR3200C**  
**638,99 €**



## Kombinované kladivo

HR3540C 35 mm, SDS-MAX

350 

Príkon	850 W
Síla príklepu	EPTA-Procedure 05/2009: 5,6 J
Max. vrtací výkon	Betón: 35 mm Železo: 13 mm Drevo: 32 mm
Vrtanie s korunkou:	90 mm
Počet úderov / min <sup>-1</sup>	1.650 – 3.300
Voľnobežné otáčky	315 – 630
Úroveň akustického tlaku	93 dB(A)
Úroveň akustického výkonu	104 dB(A)
Vibrácie	Vrtanie s príklepom do betónu: 18,0 m/s <sup>2</sup> Vrtanie do železa: 2,5 m/s <sup>2</sup>
Rozmery	439x108x239 mm
Hmotnosť	5,2 – 5,3 kg

**HR3540C**  
**669,99 €**

## Kombinované kladivo

HR4013C 40 mm, SDS-MAX

350 

Príkon	1.100 W
Síla príklepu	EPTA-Procedure 05/2009: 8 J
Max. vrtací výkon	Betón s vrtákom: 40 mm Betón s vrtacou korunkou: 105 mm
Počet úderov / min <sup>-1</sup>	1.450 – 2.900
Voľnobežné otáčky	250 – 500
Úroveň akustického tlaku	92 dB(A)
Úroveň akustického výkonu	103 dB(A)
Vibrácie	Sekanie s bočnou rukoväťou: 4,5 m/s <sup>2</sup> Vrtanie s príklepom do betónu: 5,0 m/s <sup>2</sup>
Rozmery	479x112x263 mm
Hmotnosť	6,8 – 6,9 kg
Dĺžka privodného kábla	5,0 m

**HR4013C**  
**648,99 €**

## Kombinované kladivo

HR4003C 40 mm, SDS-MAX

350 

Príkon	1.100 W
Síla príklepu	EPTA-Procedure 05/2009: 8,3 J
Max. vrtací výkon	Betón s vrtákom: 40 mm Betón s vrtacou korunkou: 105 mm
Počet úderov / min <sup>-1</sup>	1.450 – 2.900
Voľnobežné otáčky	250 – 500
Úroveň akustického tlaku	92 dB(A)
Úroveň akustického výkonu	103 dB(A)
Vibrácie	Sekanie s bočnou rukoväťou: 9,0 m/s <sup>2</sup> Vrtanie s príklepom do betónu: 10,0 m/s <sup>2</sup>
Rozmery	479x106x263 mm
Hmotnosť	6,2 – 6,4 kg
Dĺžka privodného kábla	5,0 m

**HR4003C**  
**594,99 €**

## Kombinované kladivo

HR4002 40 mm, SDS-MAX

350 

Príkon	1.050 W
Síla príklepu	EPTA-Procedure 05/2009: 6,1 J
Max. vrtací výkon	Betón s vrtákom: 40 mm Betón s vrtacou korunkou: 105 mm
Počet úderov / min <sup>-1</sup>	2.500
Voľnobežné otáčky	680
Úroveň akustického tlaku	92 dB(A)
Úroveň akustického výkonu	103 dB(A)
Vibrácie	Vrtanie s príklepom do betónu: 17,5 m/s <sup>2</sup>
Rozmery	458x114x256 mm
Hmotnosť	6,6 – 6,8 kg
Dĺžka privodného kábla	5,0 m

**HR4002**  
**561,99 €**

## Kombinované kladivo

HR4511C 45 mm, SDS-MAX

175 

Príkon	1.350 W
Síla príklepu	EPTA-Procedure 05/2009: 9,4 J
Max. vrtací výkon	Betón s vrtákom: 45 mm Betón s vrtacou korunkou: 125 mm
Počet úderov / min <sup>-1</sup>	1.250 – 2.750
Voľnobežné otáčky	130 – 280
Úroveň akustického tlaku	94 dB(A)
Úroveň akustického výkonu	105 dB(A)
Vibrácie	Vrtanie s príklepom do betónu: 7,5 m/s <sup>2</sup> Sekanie s bočnou rukoväťou: 7,5 m/s <sup>2</sup>
Rozmery	458x136x288 mm
Hmotnosť	9,0 – 9,1 kg
Dĺžka privodného kábla	5,0 m

**HR4511C**  
**865,99 €**

**Kombinované kladivo**
**HR4501C** 45 mm, SDS-MAX

175



Prikon	1.350 W
Sila príklepu	EPTA-Procedure 05/2009: 10,1 J
Max. vrtací výkon	Betón s vrtákom: 45 mm Betón s vrtacou korunkou: 125 mm
Počet úderov / min <sup>-1</sup>	1.250 – 2.750
Voľnobežné otáčky	130 – 280
Úroveň akustického tlaku	94 dB(A)
Úroveň akustického výkonu	105 dB(A)
Vibrácie	Vrtanie s príklepom do betónu: 16,0 m/s <sup>2</sup> Sekanie s bočnou rukoväťou: 12,5 m/s <sup>2</sup>
Rozmery	458×121×288 mm
Hmotnosť	8,2 – 8,4 kg
Dĺžka privodného kábla	5,0 m

**HR4501C**  
**894,99 €**
**Kombinované kladivo**
**HR5212C** 52 mm, SDS-MAX

175



Prikon	1.510 W
Sila príklepu	EPTA-Procedure 05/2009: 20 J
Max. vrtací výkon	Betón s vrtákom: 52 mm Betón s vrtacou korunkou: 160 mm
Počet úderov / min <sup>-1</sup>	1.100 – 2.250
Voľnobežné otáčky	150 – 310
Úroveň akustického tlaku	98 dB(A)
Úroveň akustického výkonu	109 dB(A)
Vibrácie	Sekanie s bočnou rukoväťou: 7,0 m/s <sup>2</sup> Vrtanie s príklepom do betónu: 9,0 m/s <sup>2</sup>
Rozmery	599×140×287 mm
Hmotnosť	11,9 – 12,0 kg
Dĺžka privodného kábla	5,0 m

**HR5212C**  
**1 081,99 €**
**AVT** **SOFT**  
 ANTI VIBRATION TECHNOLOGY **NOLOAD**
**Kombinované kladivo**
**HR5202C** 52 mm, SDS-MAX

175



Prikon	1.510 W
Sila príklepu	EPTA-Procedure 05/2009: 19,1 J
Max. vrtací výkon	Betón s vrtákom: 52 mm Betón s vrtacou korunkou: 160 mm
Počet úderov / min <sup>-1</sup>	1.100 – 2.250
Voľnobežné otáčky	150 – 310
Úroveň akustického tlaku	99 dB(A)
Úroveň akustického výkonu	110 dB(A)
Vibrácie	Sekanie s bočnou rukoväťou: 10,5 m/s <sup>2</sup> Vrtanie s príklepom do betónu: 17,0 m/s <sup>2</sup>
Rozmery	599×134×287 mm
Hmotnosť	10,9 – 11,1 kg
Dĺžka privodného kábla	5,0 m

**HR5202C**  
**973,99 €**
**Sekacie kladivo**
**HM0871C** SDS-MAX

350



Prikon	1.100 W
Sila príklepu	EPTA-Procedure 05/2009: 8,1 J
Počet úderov / min <sup>-1</sup>	1.100 – 2.650
Úroveň akustického tlaku	86 dB(A)
Úroveň akustického výkonu	97 dB(A)
Vibrácie	Sekanie s bočnou rukoväťou: 8,0 m/s <sup>2</sup>
Rozmery	466×116×230 mm
Hmotnosť	5,6 – 5,8 kg
Dĺžka privodného kábla	5,0 m

**HM0871C**  
**571,99 €**
**AVT** **SOFT**  
 ANTI VIBRATION TECHNOLOGY **NOLOAD**
**Sekacie kladivo**
**HM0870C** SDS-MAX

350



Prikon	1.100 W
Sila príklepu	EPTA-Procedure 05/2009: 7,6 J
Počet úderov / min <sup>-1</sup>	1.100 – 2.650
Úroveň akustického tlaku	87 dB(A)
Úroveň akustického výkonu	98 dB(A)
Vibrácie	Sekanie s bočnou rukoväťou: 11,0 m/s <sup>2</sup>
Rozmery	449×109×230 mm
Hmotnosť	5,1 – 5,3 kg
Dĺžka privodného kábla	5,0 m

**HM0870C**  
**519,99 €**



## Búracie kladivo

HM1111C SDS-MAX

175 

Sekáč je súčasťou dodávky.



Príkon	1.300 W
Síla príklepu	EPTA-Procedure 05/2009: 11,2 J
Počet úderov / min <sup>-1</sup>	1.100 – 2.650
Vibrácie	Sekanie s bočnou rukoväťou: 7,5 m/s <sup>2</sup>

Úroveň akustického tlaku	88 dB(A)
Úroveň akustického výkonu	99 dB(A)
Rozmery	528x126x247 mm
Hmotnosť	7,8 – 8,0 kg
Dĺžka privodného kábla	4,0 m

**AVT**  
ANTI VIBRATION TECHNOLOGY

**HM1111C**  
757,99 €

## Búracie kladivo

HM1101C SDS-MAX

175 

Sekáč je súčasťou dodávky.



Príkon	1.300 W
Síla príklepu	EPTA-Procedure 05/2009: 11,5 J
Počet úderov / min <sup>-1</sup>	1.100 – 2.650
Vibrácie	Sekanie s bočnou rukoväťou: 13,5 m/s <sup>2</sup>
Úroveň akustického tlaku	90 dB(A)
Úroveň akustického výkonu	101 dB(A)
Rozmery	528x115x247 mm
Hmotnosť	7,2 – 7,3 kg
Dĺžka privodného kábla	4,0 m

**HM1101C**  
703,99 €

## Búracie kladivo

HM1213C SDS-MAX

175 

Sekáč je súčasťou dodávky.



Príkon	1.510 W
Síla príklepu	EPTA-Procedure 05/2009: 18,6 J
Počet úderov / min <sup>-1</sup>	950 – 1.900
Úroveň akustického tlaku	75 dB(A)
Úroveň akustického výkonu	95 dB(A)
Vibrácie	Sekanie s bočnou rukoväťou: 8,0 m/s <sup>2</sup>
Rozmery	576x149x265 mm
Hmotnosť	10,8 kg
Dĺžka privodného kábla	5,0 m

**HM1213C**  
769,99 €

## Búracie kladivo

HM1205C SDS-MAX

175 

Sekáč je súčasťou dodávky.



Príkon	1.510 W
Síla príklepu	EPTA-Procedure 05/2009: 19,1 J
Počet úderov / min <sup>-1</sup>	950 – 1.900
Úroveň akustického tlaku	79 dB(A)
Úroveň akustického výkonu	93 dB(A)
Vibrácie	Sekanie s bočnou rukoväťou: 18,5 m/s <sup>2</sup>
Rozmery	576x128x265 mm
Hmotnosť	9,7 kg
Dĺžka privodného kábla	5,0 m

**HM1205C**  
655,99 €

## Búracie kladivo

HM1203C SDS-MAX

175 

Sekáč je súčasťou dodávky.



Príkon	1.510 W
Síla príklepu	EPTA-Procedure 05/2009: 19,1 J
Počet úderov / min <sup>-1</sup>	950 – 1.900
Úroveň akustického tlaku	81 dB(A)
Úroveň akustického výkonu	95 dB(A)
Vibrácie	Sekanie s bočnou rukoväťou: 16,5 m/s <sup>2</sup>
Rozmery	576x128x265 mm
Hmotnosť	9,7 kg
Dĺžka privodného kábla	5,0 m

**HM1203C**  
655,99 €

## Búracie kladivo

HM1214C SDS-MAX

175 



Sekáč je súčasťou dodávky.

**AVT** **SOFT**  
ANTI VIBRATION TECHNOLOGY **NO LOAD**



Prikon	1.510 W
Sila príklepu	EPTA-Procedure 05/2009: 19,9 J
Počet úderov / min <sup>-1</sup>	950 – 1.900
Úroveň akustického tlaku	78 dB(A)
Úroveň akustického výkonu	98 dB(A)
Rozmery	700×129×265 mm
Hmotnosť	12,3 kg
Dĺžka privodného kábla	5,0 m

**HM1214C**  
**865,99 €**

## Búracie kladivo

HM1317C 30 mm Hex

175 



Sekáč je súčasťou dodávky.

**AVT** **SOFT**  
ANTI VIBRATION TECHNOLOGY **NO LOAD**



Prikon	1.510 W
Sila príklepu	EPTA-Procedure 05/2009: 25 J
Počet úderov / min <sup>-1</sup>	730 – 1.450
Úroveň akustického tlaku	81 dB(A)
Úroveň akustického výkonu	101 dB(A)
Vibrácie	Sekanie s bočnou rukoväťou: 8,5 m/s <sup>2</sup>
Rozmery	715×129×266 mm
Hmotnosť	17 kg
Dĺžka privodného kábla	5,0 m

**HM1317C**  
**1 081,99 €**

## Búracie kladivo

HM1307C 30 mm Hex

175 



Sekáč je súčasťou dodávky.

**AVT** **SOFT**  
ANTI VIBRATION TECHNOLOGY **NO LOAD**



Prikon	1.510 W
Sila príklepu	EPTA-Procedure 05/2009: 25,5 J
Počet úderov / min <sup>-1</sup>	730 – 1.450
Úroveň akustického tlaku	81 dB(A)
Úroveň akustického výkonu	101 dB(A)
Vibrácie	Sekanie s bočnou rukoväťou: 12,5 m/s <sup>2</sup>
Rozmery	715×129×266 mm
Hmotnosť	15,3 kg
Dĺžka privodného kábla	5,0 m

**HM1307C**  
**999,99 €**

## Búracie kladivo

HM1317CB 28,6 mm Hex

175 



Sekáč je súčasťou dodávky.

**AVT** **SOFT**  
ANTI VIBRATION TECHNOLOGY **NO LOAD**



Prikon	1.510 W
Sila príklepu	EPTA-Procedure 05/2009: 26,5 J
Počet úderov / min <sup>-1</sup>	730 – 1.450
Úroveň akustického tlaku	81 dB(A)
Úroveň akustického výkonu	101 dB(A)
Vibrácie	Sekanie s bočnou rukoväťou: 7,0 m/s <sup>2</sup>
Rozmery	824×129×266 mm
Hmotnosť	19 kg
Dĺžka privodného kábla	5,0 m

**HM1317CB**  
**1 297,99 €**

## Búracie kladivo

HM1307CB 28,6 mm Hex

175 



Sekáč je súčasťou dodávky.

**AVT** **SOFT**  
ANTI VIBRATION TECHNOLOGY **NO LOAD**



Prikon	1.510 W
Sila príklepu	EPTA-Procedure 05/2009: 23,6 J
Počet úderov / min <sup>-1</sup>	730 – 1.450
Úroveň akustického tlaku	81 dB(A)
Úroveň akustického výkonu	101 dB(A)
Vibrácie	Sekanie s bočnou rukoväťou: 12,0 m/s <sup>2</sup>
Rozmery	824×129×266 mm
Hmotnosť	17,3 kg
Dĺžka privodného kábla	5,0 m

**HM1307CB**  
**1 243,99 €**

## Búracie kladivo

HM1501 30 mm Hex

175 

Príkon	1.850 W
Síla príklepu	EPTA-Procedure 05/2009: 48.0 J
Počet úderov / min <sup>-1</sup>	1.300
Rozmery	781×130×265 mm
Hmotnosť	18,4 kg
Dĺžka privodného kábla	5 m

**HM1501**  
**1 189,99 €**

## Búracie kladivo

HM1502 28,6 mm Hex

175 

Príkon	1.850 W
Síla príklepu	EPTA-Procedure 05/2009: 48.0 J
Počet úderov / min <sup>-1</sup>	1.300
Rozmery	809×130×265 mm
Hmotnosť	19,8 kg
Dĺžka privodného kábla	5 m

**HM1502**  
**1 297,99 €**

## Búracie kladivo

HM1511 30 mm Hex

175 

Príkon	1.850 W
Síla príklepu	EPTA-Procedure 05/2009: 48.0 J
Počet úderov / min <sup>-1</sup>	1.300
Rozmery	781×130×265 mm
Hmotnosť	19,2 kg
Dĺžka privodného kábla	5 m

**HM1511**  
**1 243,99 €**
**AVT** **SOFT**  
ANTI VIBRATION TECHNOLOGY **NO LOAD**

## Búracie kladivo

HM1512 28,6 mm Hex

175 

Príkon	1.850 W
Síla príklepu	EPTA-Procedure 05/2009: 48.0 J
Počet úderov / min <sup>-1</sup>	1.300
Rozmery	809×130×265 mm
Hmotnosť	20,8 kg
Dĺžka privodného kábla	5 m

**HM1512**  
**1 351,99 €**
**AVT** **SOFT**  
ANTI VIBRATION TECHNOLOGY **NO LOAD**

## Búracie kladivo

HM1802 28,6 mm Hex

218 

Príkon	2.000 W
Síla príklepu	EPTA-Procedure 05/2009: 71,4 J
Počet úderov / min <sup>-1</sup>	870
Úroveň akustického tlaku	95 dB(A)
Úroveň akustického výkonu	106 dB(A)
Rozmery	843×210×608 mm
Hmotnosť	29,4 kg
Dĺžka privodného kábla	5,0 m

**HM1802**  
**1 622,99 €**

Sekáč je súčasťou dodávky.





Sekáč je súčasťou dodávky.

**AVT** **SOFT**  
ANTI VIBRATION TECHNOLOGY **NO LOAD**



Prikon	2.000 W
Sila príklepu	EPTA-Procedure 05/2009: 72,8 J
Počet úderov / min <sup>-1</sup>	870
Úroveň akustického tlaku	96 dB(A)
Úroveň akustického výkonu	107 dB(A)
Rozmery	843×210×608 mm
Hmotnosť	31,3 kg
Dĺžka privodného kábla	5,0 m

**HM1812**  
**1 838,99 €**



Sekáč je súčasťou dodávky.



Prikon	550 W
Sila príklepu	EPTA-Procedure 05/2009: 3,1 J
Počet úderov / min <sup>-1</sup>	0 – 3.200
Rozmery	351×102×203 mm
Hmotnosť	3,4 kg
Dĺžka privodného kábla	5,0 m

**HK1820**  
**519,99 €**



# Vrtanie / vrtanie s príklepom

\*s odsávaním

Model	Typ	Max. vŕtací výkon	Príkon (W)	Energia príklepu (J)		Hmotnosť (kg)	AVT	Kontrola otáčok	Svetlo	Rýchlo-sklučovadlo
				EPTA Procedure 05/2009	Makita					
<b>SDS-Plus</b>										
HR1841F/ HR1840	Vŕtacie	18	470	1,4	1,4					
HR2230	Vŕtacie	22	710	2,2	2,3	2,6 - 3,1 kg (5,8 - 6,8 lbs)				
HR2320T	Kombinované	23	720	2,3	2,3	2,9 - 3,2 kg (6,4 - 7,0 lbs)				•
HR2300	Vŕtacie	23	720	2,3	2,3	2,7 - 3,1 kg (5,9 - 6,9 lbs)				
HR2470FT	Kombinované	24	780	2,4	2,7	3,0 - 3,3 kg (6,7 - 7,3 lbs)			•	•
HR2470T	Kombinované	24	780	2,4	2,7	3,0 - 3,3 kg (6,7 - 7,3 lbs)				•
HR2470/F	Kombinované	24	780	2,4	2,7	2,9 - 3,3 kg (6,4 - 7,3 lbs)			-/•	
HR2460/F	Vŕtacie	24	780	2,4	2,7	2,8 - 3,2 kg (6,1 - 7,0 lbs)			-/•	
HR2475(D handle)	Kombinované	24	780	2,3	2,7	3,0 - 3,4 kg (6,6 - 7,6 lbs)				
*HR2651T	Kombinované	26	800	2,2	2,9	3,2 - 4,4 kg (7,1 - 9,7 lbs)	•			•
*HR2651	Kombinované	26	800	2,2	2,9	3,1 - 4,2 kg (6,9 - 9,3 lbs)	•			
*HR2650	Kombinované	26	800	2,2	2,9	3,0 - 4,1 kg (6,7 - 9,1 lbs)				
*HR2661(D handle)	Kombinované	26	800	2,2	2,9					
HR2641(D handle)	Kombinované	26	800	2,4	2,9	3,1 - 3,5 kg (6,8 - 7,8 lbs)	•			
HR2631FT	Kombinované	26	800	2,4	2,9	3,1 - 3,6 kg (6,8 - 7,9 lbs)	•		•	•
HR2631F	Kombinované	26	800	2,4	2,9	2,9 - 3,4 kg (6,4 - 7,4 lbs)	•		•	
HR2630T	Kombinované	26	800	2,4	2,9	3,0 - 3,5 kg (6,6 - 7,7 lbs)				•
HR2630	Kombinované	26	800	2,4	2,9	2,8 - 3,3 kg (6,3 - 7,2 lbs)				
HR2601	Vŕtacie	26	800	2,4	2,9	3,1 - 3,6 kg (6,9 - 7,8 lbs)	•			
HR2600	Vŕtacie	26	800	2,4	2,9	3,0 - 3,4 kg (6,5 - 7,5 lbs)				
HR2811FT	Kombinované	28	800	2,9	2,9	3,6 - 3,9 kg (8,0 - 8,6 lbs)			•	•
HR2811F	Kombinované	28	800	2,8	2,9	3,5 - 3,9 kg (7,7 - 8,7 lbs)			•	
HR2810T	Kombinované	28	800	2,9	2,9	3,5 - 3,8 kg (7,8 - 8,4 lbs)				•
HR2810	Kombinované	28	800	2,8	2,9	3,4 - 3,8 kg (7,5 - 8,5 lbs)				
HR2800	Vŕtacie	28	800	2,8	2,9					
HR3001C	Kombinované	30	1.050	3,6	4,5					
HR3011FC	Kombinované	30	1.050	3,6	4,5	4,4 - 4,9 kg (9,7 - 10,8 lbs.)	•		•	
HR3012FC	Kombinované	30	1.050	3,6	4,5	4,5 - 4,8 kg (9,9 - 10,6 lbs.)	•		•	•
HR3210FCT	Kombinované	32	850	4,9	5,5	5,4 - 5,6 kg (11,9 - 12,3 lbs)	•		•	•
HR3210C	Vŕtacie	32	850	5	5,5	5,2 - 5,6 kg (11,4 - 12,4 lbs)	•			
HR3200C	Kombinované	32	850	5,1	5,5	4,8 - 5,2 kg (10,5 - 11,5 lbs)				
<b>17 mm HEX</b>										
HR3530	Vŕtacie	35	1.010	-	6,2	5,8 kg (12,8 lbs)				
HR4030C	Vŕtacie	40	1.100	-	9,2	6,9 kg (15,2 lbs)				
<b>19 mm HEX</b>										
<b>Drážková hriadeľ</b>										
HR4041C	Vŕtacie	40	1.100		9,2	6,7 kg (14,8 lbs)				
<b>SDS Max</b>										
HR3541FC	Kombinované	35	850	5,7	6,3					
HR3540C	Kombinované	35	850	5,6	6,3	5,2 - 5,3 kg (11,4 - 11,6 lbs)				
HR4013C	Vŕtacie	40	1.100	8	11,4	6,8 - 6,9 kg (14,9 - 15,3 lbs)	•	•		
HR4003C	Vŕtacie	40	1.100	8,3	11,4	6,2 - 6,4 kg (13,7 - 14,1 lbs)				
HR4002	Vŕtacie	40	1.050	6,1	6,2	6,6 - 6,8 kg (14,6 - 15,0 lbs)				
HR4511C	Vŕtacie	45	1.350	9,4	12,5	9,0 - 9,1 kg (19,8 - 20,1 lbs)	•			
HR4510C	Vŕtacie	45	1.350	9,4	12,5	8,9 - 9,0 kg (19,5 - 19,9 lbs)	•			
HR4501C	Vŕtacie	45	1.350	10,1	12,5	8,2 - 8,4 kg (18,1 - 18,5 lbs)				
HR5212C	Vŕtacie	52	1.510	20	21	11,9 - 12,0 kg (26,2 - 26,5 lbs)	•	•		
HR5202C	Vŕtacie	52	1.510	19,1	21	10,9 - 11,1 kg (24,1 - 24,4 lbs)				

## REZANIE



-  Dvojitá izolácia
-  Nastavenie otáčok
-  Brzda
-  Obmedzovač momentu
-  Konštantné otáčky
-  Obmedzovač rozbehového prúdu
-  Rez v oblúku
-  Bajonetové upínanie
-  Zabudované osvetlenie
-  Rez pod uhlom
-  Odsávanie prachu
-  Prepravný kufor



## Diamantová rezačka

4100KB 125 mm

303



Príkon	1.400 W
Priemer kotúča	125 mm
Max. rezný výkon	40,0 mm
Voľnobežné otáčky	12.200
Výbracie	Rezanie betónu: 6,0 m/s <sup>2</sup>
Uroveň akustického tlaku	96 dB(A)
Uroveň akustického výkonu	107 dB(A)
Rozmery	231×220×179 mm
Hmotnosť	3,0 kg
Dĺžka privodného kábla	2,5 m

Pripojenie na lištu s adaptérom 198673-2



**4100KB**  
**151,99 €**

## Rezačka

4112HS 305 mm

204



Príkon	2.400 W
Max. rezný výkon	100 mm
Priemer kotúča	305 mm
Voľnobežné otáčky	5.000
Celková dĺžka	648 mm
Hmotnosť	10,4 kg
Dĺžka privodného kábla	2,5 m



**4112HS**  
**703,99 €**

## Drážkovacia fréza

SG1251 125 mm

318



Príkon	1.400 W
Max. rezný výkon	Hĺbka: 0 – 30 mm
	Šírka: 6 – 30 mm
Priemer kotúča	125 mm
Voľnobežné otáčky	10.000
Rozmery	350×151×178 mm
Hmotnosť	4,3 kg
Dĺžka privodného kábla	5,0 m



**SG1251J**  
**561,99 €**

## Drážkovacia fréza

SG181 180 mm

318



Príkon	2.150 W
Max. rezný výkon	Hĺbka: 15 – 60 mm
	Šírka: 9 – 43 mm
Priemer kotúča	180 mm
Voľnobežné otáčky	7.200
Hmotnosť	5,6 kg



**SG181**  
**1 189,99 €**

## Drážkovacia fréza

SG150 150 mm



Príkon	1.800 W
Priemer kotúča	150 mm
Max. rezný výkon	Hĺbka: 7 – 45 mm
	Šírka: 7 – 35 mm
Voľnobežné otáčky	7.800
Celková dĺžka	410 mm
Hmotnosť	5,6 kg



**SG150**  
**919,99 €**

**Rezač na železo**
**LC1230** 305 mm

203



Prikon	1.750 W
Priemer kotúča	305 mm
Max. rezný výkon	90°: 115 mm
	90°: 75×150 mm
	45°: 90 mm
	45°: 85×85 mm
Voľnobežné otáčky	1.300
Rozmery	516×306×603 mm
Hmotnosť	19,3 kg
Dĺžka privodného kábla	2,5 m

**LC1230N**  
**592,99 €**
**Rezač na železo**
**LW1401** 355 mm

203



Prikon	2.200 W
Priemer kotúča	355 mm
Voľnobežné otáčky	3.800
Max. rezný výkon 90°	Gulatina: 127 mm
	Profil – obdĺžnik: 115×130 mm
	Profil – obdĺžnik: 102×194 mm
	Profil – obdĺžnik: 70×233 mm
Max. rezný výkon 45°	Gulatina: 127 mm
	Profil – obdĺžnik: 115×103 mm
Vibrácie	2,5 m/s <sup>2</sup>
Úroveň akustického tlaku	102 dB(A)
Úroveň akustického výkonu	110 dB(A)
Rozmery	500×295×640 mm
Hmotnosť	18,3 kg

**LW1401**  
**279,99 €**
**Nožnice**
**JS1601** 1,6 mm

459



Prikon	380 W
Max. rezný výkon	Oceľ do 400 N/mm <sup>2</sup> : 1,6 mm
	Oceľ do 600 N/mm <sup>2</sup> : 1,2 mm
	Oceľ do 800 N/mm <sup>2</sup> : 0,8 mm
	Hliník do 200 N/mm <sup>2</sup> : 2,5 mm
Min. rádius	250 mm
Počet strihov za minútu	4.500
Rozmery	320×70×78 mm
Hmotnosť	1,4 kg
Dĺžka privodného kábla	2,5 m

**JS1601**  
**395,99 €**
**Nožnice**
**JS1000** 1,6 mm

459



Prikon	380 W
Max. rezný výkon	Oceľ do 400 N/mm <sup>2</sup> : 1,0 mm
	Oceľ do 600 N/mm <sup>2</sup> : 0,7 mm
	Oceľ do 800 N/mm <sup>2</sup> : 0,5 mm
	Hliník do 200 N/mm <sup>2</sup> : 2,5 mm
Min. rádius	30 mm
Počet strihov za minútu	4.500
Rozmery	322×70×78 mm
Hmotnosť	1,4 kg
Dĺžka privodného kábla	2,5 m

**JS1000**  
**405,99 €**
**Nožnice**
**JS1602** 1,6 mm

325



Prikon	380 W
Max. rezný výkon	Oceľ do 400 N/mm <sup>2</sup> : 1,6 mm
	Oceľ do 600 N/mm <sup>2</sup> : 1,2 mm
	Oceľ do 800 N/mm <sup>2</sup> : 0,8 mm
	Hliník do 200 N/mm <sup>2</sup> : 2,5 mm
Min. rádius	30 mm
Počet strihov za minútu	4.000
Rozmery	255×74×146 mm
Hmotnosť	1,6 kg
Dĺžka privodného kábla	2,5 m

**JS1602**  
**346,99 €**

## Nožnice

JS3201 3,2 mm

303



Príkon	710 W
Max. rezný výkon	Oceľ do 400 N/mm <sup>2</sup> : 3,2 mm Oceľ do 600 N/mm <sup>2</sup> : 2,5 mm Oceľ do 800 N/mm <sup>2</sup> : 1,5 mm Hliník do 200 N/mm <sup>2</sup> : 4,0 mm
Min. rádius	50 mm
Počet strihov za minútu	1.600
Rozmery	213×90×239 mm
Hmotnosť	3,4 kg
Dĺžka privodného kábla	2,5 m

**JS3201J**  
**465,99 €**

## Prestrihovač

JN1601 1,6 mm

411



Príkon	550 W
Max. rezný výkon	Oceľ do 400 N/mm <sup>2</sup> : 1,6 mm Oceľ do 600 N/mm <sup>2</sup> : 1,2 mm Oceľ do 800 N/mm <sup>2</sup> : 0,8 mm Hliník do 200 N/mm <sup>2</sup> : 2,5 mm
Min. rádius	Vonkajší obvod: 50 mm Vnútorý obvod: 45 mm
Počet strihov za minútu	2.200
Celková dĺžka	261 mm
Hmotnosť	1,6 kg
Dĺžka privodného kábla	2,0 m

**JN1601**  
**457,99 €**

## Prestrihovač

JN3201 3,2 mm

303



Príkon	710 W
Max. rezný výkon	Oceľ do 400 N/mm <sup>2</sup> : 3,2 mm Oceľ do 600 N/mm <sup>2</sup> : 2,5 mm Oceľ do 800 N/mm <sup>2</sup> : 1,0 mm Hliník do 200 N/mm <sup>2</sup> : 3,5 mm
Min. rádius	Vonkajší obvod: 128 mm Vnútorý obvod: 120 mm
Počet strihov za minútu	1.300
Rozmery	225×90×254 mm
Hmotnosť	3,4 kg
Dĺžka privodného kábla	2,5 m

**JN3201J**  
**675,99 €**

## Rezač hliníkových profilov

CA5000 118 mm

303













Príkon	1.300 W
Rezný kotúč	Rezný kotúč / TCT kotúč
Max. rezný výkon s rezným kotúčom	S lištou: 11 mm
Max. rezný výkon s TCT kotúčom	S lištou: 36 mm Bez lišty: 41 mm
Voľnobežné otáčky	2.200 – 6.400
Rozmery	346×250×250 mm
Hmotnosť	4,7 kg
Dĺžka privodného kábla	2,5 m

**CA5000XJ**  
**675,99 €**



## ▣ BRÚSENIE / LEŠTENIE



-  Dvojitá izolácia
-  Nastavenie otáčok
-  Brzda
-  El. nastavenie otáčok /2 rýchlosti/
-  Obmedzovač momentu
-  Konštantné otáčky
-  Obmedzovač rozbehového prúdu
-  Háč / klip
-  Odsávanie prachu
-  Zabudované osvetlenie
-  Prepravný kufor

## Uhlová brúska

GA5021C / GA6021C Anti-restart, plynulý rozbeh, veľký vypínač

253 

	GA5021C	GA6021C
Príkon	1.450 W	1.450 W
Priemer kotúča	125 mm	150 mm
Voľnobežné otáčky	10.000	9.000
Vibrácie	Plošné brúsenie: 8,5 m/s <sup>2</sup> Brúsenie kotúčom: 2,5 m/s <sup>2</sup>	Plošné brúsenie: 8,5 m/s <sup>2</sup> Brúsenie kotúčom: 2,5 m/s <sup>2</sup>
Úroveň akustického tlaku	90 dB(A)	90 dB(A)
Úroveň akustického výkonu	101 dB(A)	101 dB(A)
Rozmery	390×139×120 mm	390×169×120 mm
Hmotnosť	2,9 – 4,1 kg	3,0 – 3,5 kg
Dĺžka privodného kábla	2,5 m	2,5 m

GA5021C  
184,99 €GA6021C  
195,99 €

## Uhlová brúska

GA6040C SJS II, regulácia otáčok, Anti-restart, plynulý rozbeh, posuvný vypínač

318 

Príkon	1.400 W
Priemer kotúča	150 mm
Voľnobežné otáčky	4.000 – 9.000
Vibrácie	Plošné brúsenie s antivibračnou rukoväťou: 6,0 m/s <sup>2</sup> Brúsenie kotúčom s antivibračnou rukoväťou: 2,5 m/s <sup>2</sup>
Úroveň akustického tlaku	87 dB(A)
Úroveň akustického výkonu	98 dB(A)
Rozmery	303×171×116 mm
Hmotnosť	2,5 – 2,9 kg
Dĺžka privodného kábla	2,5 m

GA6040C01  
173,99 €

01 – antivibračná rukoväť

## Uhlová brúska

9565CVR SJS, regulácia otáčok, Anti-restart, plynulý rozbeh, posuvný vypínač

318 

Príkon	1.400 W
Priemer kotúča	125 mm
Voľnobežné otáčky	2.800 – 12.000
Rozmery	299×139×103 mm
Hmotnosť	2,5 – 3,6 kg
Dĺžka privodného kábla	2,4 – 3,5 kg

9565CVR  
151,99 €

## Uhlová brúska

9565CR SJS, Anti-restart, plynulý rozbeh, posuvný vypínač

318 

Príkon	1.400 W
Priemer kotúča	125 mm
Voľnobežné otáčky	12.000
Vibrácie	Plošné brúsenie s antivibračnou rukoväťou: 7,5 m/s <sup>2</sup> Brúsenie kotúčom: 2,5 m/s <sup>2</sup>
Úroveň akustického tlaku	82 dB(A)
Úroveň akustického výkonu	93 dB(A)
Rozmery	299×139×103 mm
Hmotnosť	2,4 – 3,5 kg
Dĺžka privodného kábla	2,5 m

9565CR  
141,99 €

## Uhlová brúska

GA5050 plynulý rozbeh

303 

Príkon	1.300 W
Priemer kotúča	125 mm
Voľnobežné otáčky	11 000
Vibrácie	2,5 m/s <sup>2</sup>
Úroveň akustického tlaku	91 dB(A)
Úroveň akustického výkonu	102 dB(A)
Rozmery	325×140×117 mm
Hmotnosť	2,5 kg
Dĺžka privodného kábla	2,5 m

GA5050R  
151,99 €



## Uhlová brúška

GA5080 Anti-reštart, plynulý rozbeh, posuvný vypínač, Xlock

**NOVINKA**

303 



Prikon	1.400 W
Priemer kotúča	125 mm
Voľnobežné otáčky	12 000
Vibrácie	7,5 m/s <sup>2</sup>
Úroveň akustického tlaku	84 dB(A)
Úroveň akustického výkonu	95 dB(A)
Rozmery	309×141×113 mm
Hmotnosť	2,5 – 3,6 kg
Dĺžka prívodného kábla	2,5 m



**GA5080RX02**  
**184,99 €**

## Uhlová brúška

GA6021 SJS, veľký vypínač

303 



Prikon	1.050 W
Priemer kotúča	150 mm
Voľnobežné otáčky	10.000
Vibrácie	
Plošné brúsenie:	6,5 m/s <sup>2</sup>
Brúsenie kotúčom:	2,5 m/s <sup>2</sup>
Úroveň akustického tlaku	89 dB(A)
Úroveň akustického výkonu	100 dB(A)
Rozmery	384×172×120 mm
Hmotnosť	2,8 – 3,2 kg
Dĺžka prívodného kábla	2,5 m



**GA6021**  
**162,99 €**

## Uhlová brúška

9557HNR / 9558HNR Anti-restart, plynulý rozbeh, posuvný vypínač

325 



Prikon	840 W	840 W
Priemer kotúča	115 mm	125 mm
Voľnobežné otáčky	11.000	11.000
Vibrácie		
Plošné brúsenie	7,5 m/s <sup>2</sup>	8,5 m/s <sup>2</sup>
Brúsenie kotúčom	2,5 m/s <sup>2</sup>	2,5 m/s <sup>2</sup>
Úroveň akustického tlaku	86 dB(A)	86 dB(A)
Úroveň akustického výkonu	97 dB(A)	97 dB(A)
Rozmery	271×130×106 mm	271×140×106 mm
Hmotnosť	1,7 – 2,4 kg	1,7 – 3,2 kg
Dĺžka prívodného kábla	2,5 m	2,5 m



**9557HNRG**  
**81,99 €**

**9558HNRG**  
**87,99 €**

**9558HNRGK**  
**97,99 €**

X1 – 5 ks rezný kotúč 125 x 0,8 mm

## Uhlová brúška

GA4530R / GA5030R Anti-restart, plynulý rozbeh, posuvný vypínač

459 



Prikon	720 W	720 W
Priemer kotúča	115 mm	125 mm
Voľnobežné otáčky	11.000	11.000
Vibrácie		
Plošné brúsenie:	7,5 m/s <sup>2</sup>	8,5 m/s <sup>2</sup>
Brúsenie kotúčom:	2,5 m/s <sup>2</sup>	2,5 m/s <sup>2</sup>
Úroveň akustického tlaku	85 dB(A)	85 dB(A)
Úroveň akustického výkonu	96 dB(A)	96 dB(A)
Rozmery	266×130×108 mm	266×140×108 mm
Hmotnosť	1,88 – 2,22 kg	1,91 – 3,06 kg
Dĺžka prívodného kábla	2,5 m	2,5 m



**GA4530R**  
**65,99 €**

**GA5030R**  
**71,99 €**

**GA5030RSP4**  
**129,99 €**

**GA5030RX1**  
**85,99 €**

SP4 – 4 ks lamelový kotúč, 1 ks diamantový kotúč, šiltovka;  
X1 – 5 ks rezný kotúč 125 x 0,8 mm

## Uhlová brúška

GA9040R Anti-restart, plynulý rozbeh, veľký vypínač

204 



Prikon	2.600 W
Priemer kotúča	230 mm
Voľnobežné otáčky	6.600
Vibrácie	
Plošné brúsenie:	6,0 m/s <sup>2</sup>
Brúsenie kotúčom:	2,5 m/s <sup>2</sup>
Úroveň akustického tlaku	90 dB(A)
Úroveň akustického výkonu	101 dB(A)
Rozmery	503×250×140 mm
Hmotnosť	6,69 – 8,98 kg
Dĺžka prívodného kábla	2,5 m



**GA9040R**  
**216,99 €**

**GA9040RF01**  
**227,99 €**

R01 – antivibračná rukoväť



## Uhlová brúska

GA9030 Veľký vypínač

204 

Príkon	2.400 W
Priemer kotúča	230 mm
Voľnobežné otáčky	6.600
Vibrácie	Plošné brúsenie: 6,5 m/s <sup>2</sup> Brúsenie kotúčom: 2,5 m/s <sup>2</sup>
Úroveň akustického tlaku	90 dB(A)
Úroveň akustického výkonu	101 dB(A)
Rozmery	503x250x140 mm
Hmotnosť	6,26 – 8,55 kg
Dĺžka privodného kábla	2,5 m

GA9030X1  
185,99 €

X01 – antivibračná rukoväť

## Uhlová brúska

GA9062R D-rukovät, Anti-restart, plynulý rozbeh, veľký vypínač

218 

Príkon	2.200 W
Priemer kotúča	230 mm
Voľnobežné otáčky	6.600
Vibrácie	Plošné brúsenie s antivibračnou rukoväťou: 6,0 m/s <sup>2</sup> Brúsenie kotúčom s antivibračnou rukoväťou: 2,5 m/s <sup>2</sup>
Úroveň akustického tlaku	91 dB(A)
Úroveň akustického výkonu	102 dB(A)
Rozmery	450x250x144 mm
Hmotnosť	5,65 – 8,01 kg
Dĺžka privodného kábla	2,5 m (8,2 ft.)

GA9062R  
195,99 €

## Uhlová brúska

GA9060R Anti-restart, plynulý rozbeh, veľký vypínač

218 

Príkon	2.200 W
Priemer kotúča	230 mm
Voľnobežné otáčky	6.600
Vibrácie	Plošné brúsenie s antivibračnou rukoväťou: 6,0 m/s <sup>2</sup> Brúsenie kotúčom s antivibračnou rukoväťou: 2,5 m/s <sup>2</sup>
Úroveň akustického tlaku	91 dB(A)
Úroveň akustického výkonu	102 dB(A)
Rozmery	450x250x144 mm
Hmotnosť	5,52 – 7,88 kg
Dĺžka privodného kábla	2,5 m

GA9060R  
184,99 €

## Uhlová brúska

GA9070 Anti-restart, plynulý rozbeh

NOVINKA

204 

Príkon	2.800 W
Priemer kotúča	230 mm
Voľnobežné otáčky	6.600
Vibrácie	4,8 m/s <sup>2</sup>
Úroveň akustického tlaku	91 dB(A)
Úroveň akustického výkonu	102 dB(A)
Rozmery	506x250x146 mm
Hmotnosť	6,3 – 8,5 kg
Dĺžka privodného kábla	2,5 m

GA9070X1  
259,99 €

## Uhlová brúska

GA9071 Anti-restart, plynulý rozbeh

NOVINKA

204 

Príkon	2.800 W
Priemer kotúča	230 mm
Voľnobežné otáčky	6.600
Vibrácie	4,9 m/s <sup>2</sup>
Úroveň akustického tlaku	91 dB(A)
Úroveň akustického výkonu	102 dB(A)
Rozmery	506x250x146 mm
Hmotnosť	6,4 – 8,5 kg
Dĺžka privodného kábla	2,5 m

GA9071X1  
259,99 €AFT 

## Uhlová brúska

GA9080 Anti reštart, plynulý rozbeh, veľký vypínač **NOVINKA**

204 



Prikon	2.700 W
Priemer kotúča	230 mm
Voľnobežné otáčky	6.600
Rozmery	499×250×144 mm
Hmotnosť	6,4 kg
Dĺžka prívodného kábla	2,5 m
Otočná zadná rukoväť	

**GA9080X1**  
209,99 €

## Uhlová brúska

GA9081 Anti reštart, plynulý rozbeh, veľký vypínač **NOVINKA**

204 



Prikon	2.700 W
Priemer kotúča	230 mm
Voľnobežné otáčky	6.600
Rozmery	499×250×144 mm
Hmotnosť	6,1 kg
Dĺžka prívodného kábla	2,5 m

**GA9081**  
176,99 €

## Uhlová brúska

GA9082 veľký vypínač **NOVINKA**

204 



Prikon	2.700 W
Priemer kotúča	230 mm
Voľnobežné otáčky	6.600
Rozmery	499×250×144 mm
Hmotnosť	6,1 kg
Dĺžka prívodného kábla	2,5 m

**GA9082**  
159,99 €

## Uhlová brúska

GA9020R Anti-restart, plynulý rozbeh, veľký vypínač

204 



Prikon	2.200 W
Priemer kotúča	230 mm
Voľnobežné otáčky	6.600
Vibrácie	Plošné brúsenie: 6,0 m/s <sup>2</sup> Brúsenie kotúčom: 2,5 m/s <sup>2</sup>
Úroveň akustického tlaku	90 dB(A)
Úroveň akustického výkonu	101 dB(A)
Rozmery	473×250×140 mm
Hmotnosť	5,80 – 8,09 kg
Dĺžka prívodného kábla	2,5 m

**GA9020RF**  
151,99 €

**GA9020RFK**  
178,99 €

## Uhlová brúska

GA7020 / GA9020 Veľký vypínač

204 



	GA7020	GA9020
Prikon	2.200 W	2.200 W
Priemer kotúča	180 mm	230 mm
Voľnobežné otáčky	8.500	6.000
Vibrácie		Plošné brúsenie: 5,5 m/s <sup>2</sup>
Plošné brúsenie s antivibračnou rukoväťou:	8,0 m/s <sup>2</sup>	
Brúsenie kotúčom:	2,5 m/s <sup>2</sup>	2,5 m/s <sup>2</sup>
Úroveň akustického tlaku	89 dB(A)	89 dB(A)
Úroveň akustického výkonu	100 dB(A)	100 dB(A)
Rozmery	473×200×140 mm	473×249×140 mm
Hmotnosť	5,56 – 6,06 kg	5,76 – 8,05 kg
Dĺžka prívodného kábla	2,5 m	2,5 m

**GA7020**  
141,99 €

**GA9020**  
151,99 €

**GA9020K**  
173,99 €

## Uhlová brúska

GA7082 180 mm

NOVINKA



Príkon	2.700 W
Priemer kotúča	180 mm
Voľnobežné otáčky	8.500
Rozmery	499x200x144 mm
Hmotnosť	6,0 kg
Dĺžka privodného kábla	2,5 m



**GA7082**  
**149,99 €**

## Uhlová brúska

GA9050R Anti-restart, plynulý rozbeh, veľký vypínač

204



Príkon	2.000 W
Priemer kotúča	230 mm
Voľnobežné otáčky	6.600
Vibrácie	Plošné brúsenie: 5,5 m/s <sup>2</sup> Brúsenie kotúčom: 2,5 m/s <sup>2</sup>
Úroveň akustického tlaku	94 dB(A)
Úroveň akustického výkonu	105 dB(A)
Rozmery	455x250x132 mm
Hmotnosť	4,82 – 7,12 kg
Dĺžka privodného kábla	2,5 m



**GA9050R**  
**141,99 €**

## Leštička

SA7000C 180 mm

204



Príkon	1.600 W
Priemer kotúča	180 mm
Max. priemer padu	Pad: 180 mm
Voľnobežné otáčky	0 – 4.000
Rozmery	453x170x136 mm
Hmotnosť	3,5 – 3,6 kg
Dĺžka privodného kábla	2,5 m



**SA7000C**  
**291,99 €**

## Leštička

9237CB 180 mm

303



Príkon	1.200 W
Max. priemer padu	Vlnový pad: 180 mm
Voľnobežné otáčky	0 – 3.200
Vibrácie	2,5 m/s <sup>2</sup>
Úroveň akustického tlaku	83 dB(A)
Úroveň akustického výkonu	94 dB(A)
Rozmery	431x198x187 mm
Hmotnosť	3,2 – 3,4 kg
Dĺžka privodného kábla	2,5 m



**9237CB**  
**363,99 €**

## Leštička

PO6000C 150 mm



Príkon	900 W
Rozmer padu	150 mm
Excentrický výkyv za minútu	0 – 6.800
Počet strihov za minútu	0 – 13.600
Voľnobežné otáčky	0 – 780
Priemer výkyvu	5,5 mm
Vibrácie	Leštenie: 7,0 m/s <sup>2</sup>
Úroveň akustického tlaku	83 dB(A)
Úroveň akustického výkonu	94 dB(A)
Rozmery	451x148x126 mm
Hmotnosť	2,8 – 3,0 kg
Dĺžka privodného kábla	4,0 m



**PO6000C**  
**378,99 €**



Model			Voľno-bežné otáčky (rpm)	Vypínač	AWS	BL motor	AFT	ADT	XPT	Brzda	Anti-reštart	X-Lock
-------	--	--	--------------------------	---------	-----	----------	-----	-----	-----	-------	--------------	--------

**40 Vmax**

100 mm	115 mm	125 mm										
GA003G	GA004G	GA005G	8 500	Posuvný	-	●	●	-	●	●	●	-
GA006G	GA007G	GA008G	8 500	Posuvný	-	●	●	-	●	-	●	-
GA011G	GA012G	GA013G	8 500	Pákový	-	●	●	-	●	●	●	-
GA014G	GA015G	GA016G	8 500	Pákový	-	●	●	-	●	-	●	-
GA021G	GA022G	GA023G	3 000 - 8 500	Posuvný	●	●	●	-	●	●	●	-
GA024G	GA025G	GA026G	3 000 - 8 500	Posuvný	●	●	●	-	●	-	●	-
GA027G	GA028G	GA029G	3 000 - 8 500	Pákový	●	●	●	-	●	●	●	-
GA030G	GA031G	GA032G	3 000 - 8 500	Pákový	●	●	●	-	●	-	●	-
GA039G	GA040G	GA041G	3 000 - 8 500	Posuvný	●	●	●	-	●	●	●	●
GA042G	GA043G	GA044G	3 000 - 8 500	Pákový	●	●	●	-	●	●	●	●
GA045G	GA046G	GA047G	8 500	Pákový	-	●	●	-	●	●	●	●

150 mm	180 mm	230 mm										
GA035G	-	-	8 500	Posuvný	-	●	●	-	●	●	●	-
GA036G	-	-	8 500	Pákový	-	●	●	-	●	●	●	-
-	GA037G	-	7 800	Veľký vypínač	●	●	●	-	●	●	●	-
-	-	GA038G	6 600	Veľký vypínač	●	●	●	-	●	●	●	-

**18 V x 2**

180 mm	230 mm											
DGA700	-	-	7 800	Veľký vypínač	-	●	●	●	●	●	●	-
DGA701	-	-	7 800	Veľký vypínač	●	●	●	●	●	●	●	-
-	DGA900	-		Veľký vypínač	-	●	●	●	●	●	●	-
-	DGA901	-		Veľký vypínač	●	●	●	●	●	●	●	-

**18 V**

100 mm	115 mm	125 mm										
DGA414	DGA464	DGA514	3 000 - 8 500	Posuvný	●	●	●	●	●	●	●	-
DGA413	DGA463	DGA513	3 000 - 8 500	Posuvný	-	●	●	●	●	●	●	-
DGA412	DGA462	DGA512	3 000 - 8 500	Posuvný	●	●	●	●	●	-	●	-
DGA411	DGA461	DGA511	3 000 - 8 500	Posuvný	-	●	●	●	●	-	●	-
DGA406	DGA456	DGA506	8 500	Posuvný	-	●	●	●	●	●	●	-
DGA404	DGA454	DGA504	8 500	Posuvný	-	●	●	●	●	-	●	-
-	-	DGA521	8 500	Posuvný	-	●	●	●	●	-	●	●
DGA402	DGA452	-	11 000	Posuvný	-	-	-	-	-	-	●	-
DGA418	DGA468	DGA518	3 000 - 8 500	Pákový	●	●	●	●	●	●	●	-
DGA417	DGA467	DGA517	3 000 - 8 500	Pákový	-	●	●	●	●	●	●	-
DGA419	DGA469	DGA519	3 000 - 8 500	Pákový	-	●	●	●	●	●	●	-
DGA408	DGA458	DGA508	8 500	Pákový	-	●	●	●	●	●	●	-
DGA405	DGA455	DGA505	8 500	Pákový	-	●	●	●	●	-	●	-
-	-	DGA520	8 500	Pákový	-	●	●	●	●	-	●	●

Model				Príkion (W)	Vypínač	SJS / SJS2	Anti-reštart	Regulácia otáčok	Brzda	Konštantné otáčky	Plynulý rozbeh	X-Lock
<b>Uhlová brúška</b>												
100 mm	115 mm	125 mm	150 mm									
-	-	GA5021C	GA6021C	1 450	Veľký vypínač	SJS	●	-	-	●	●	-
-	-	GA5020C	GA6020C	1 450	Prstový vypínač	SJS	●	-	-	●	●	-
GA4041C	GA4541C	GA5041C	-	1 400	Posuvný	SJS2	●	●	●	●	●	-
GA4040C	GA4540C	GA5040C	GA6040C	1 400	Posuvný	SJS2	●	●	-	●	●	-
-	GA4542C	GA5042C	GA6042C	1 400	Posuvný	SJS2	-	●	-	●	●	-
-	-	9565CVR	-	1 400	Posuvný	SJS	●	●	-	●	●	-
-	9564CV	9565CV	9566CV	1 400	Posuvný	SJS	-	●	-	●	●	-
-	9564CR	9565CR	9566CR	1 400	Posuvný	SJS	●	-	-	●	●	-
-	-	9565C	9566C	1 400	Posuvný	SJS	-	-	-	●	●	-
-	9564PCV	9565PCV	9566PCV	1 400	Pákový	SJS	-	●	-	●	●	-
-	9564PC	9565PC	9566PC	1 400	Pákový	SJS	-	-	-	●	●	-
-	-	9565CLR / 9565CVL	-	1 400	Posuvný	SJS	● / -	●	-	●	●	-
GA4050	GA4550 / GA4552	GA5050 / GA5052	-	1 300	Pákový	-	-	-	-	-	-	-
GA4050R	GA4550R / GA4552R	GA5050R / GA5052R	-	1 300	Pákový	-	●	-	-	-	●	-
GA4051R	GA4551R / GA4553R	GA5051R / GA5053R	-	1 300	Pákový	-	●	-	-	-	●	-
-	GA4541R	GA5041R	-	1 100	Posuvný	SJS2	●	-	●	-	●	-
-	GA4540R	GA5040R	GA6040R	1 100	Posuvný	SJS2	●	-	-	-	●	-
GA4040	GA4540	GA5040	GA6040	1 100	Posuvný	SJS2	-	-	-	-	-	-
-	9564HR	9565HR	-	1 100	Posuvný	SJS	●	-	-	-	●	-
-	9564H	9565H	-	1 100	Posuvný	SJS	-	-	-	-	-	-
-	9564P	9565P	-	1 100	Pákový	SJS	-	-	-	-	-	-
-	-	GA5021	GA6021	1 050	Veľký vypínač	SJS	-	-	-	-	-	-
-	-	GA5011	-	1 050	Veľký vypínač	-	-	-	-	-	-	-
-	-	GA5010 / GA5020	GA6010 / GA6020	1 050	Prstový vypínač	- / SJS	-	-	-	-	-	-
-	-	GA5080 / GA5080R	-	1 400	Posuvný	SJS	- / ●	-	-	●	●	●
GA4570	-	-	-	840	Posuvný	-	-	-	-	-	-	●
9556HN	9557HN	9558HN	-	840	Posuvný	-	-	-	-	-	-	-
-	9557NBR / 9557HNR	9558NBR / 9558HNR	-	840	Posuvný	-	●	-	-	-	●	-
9556HP	9557HP	9558HP	-	840	Pákový	-	-	-	-	-	-	-
9556HB	-	-	-	840	Toggle	-	-	-	-	-	-	-
GA4031 / GA4032	-	-	-	720	Toggle	-	-	-	-	-	-	-
GA4030R	GA4530R	GA5030R	-	720	Posuvný	-	●	-	-	-	●	-
GA4030	GA4530	GA5030	-	720	Posuvný	-	-	-	-	-	-	-
GA4034	GA4534	GA5034	-	720	Pákový	-	-	-	-	-	-	-
9553HN	9554HN	9555HN	-	710	Posuvný	-	-	-	-	-	-	-
9553HB / 9553B	-	-	-	710	Toggle	-	-	-	-	-	-	-
9500NB / N9500N	-	-	-	570	Toggle	-	-	-	-	-	-	-

Model		Príkion (W)	Vypínač	SJS2	Antireštart	Konštantné otáčky	Obmedzovač krútiaceho momentu	Plynulý rozbeh	X-Lock
180 mm	230 mm								
GA7070	GA9070	2 800 W	Veľký vypínač	-	●	●	●	●	-
GA7071	GA9071	2 800 W	Veľký vypínač	-	●	●	●	●	-
GA7080 / GA7081	GA9080 / GA9081	2 700 W	Veľký vypínač	-	●	-	-	●	-
GA7082	GA9082	2 700 W	Veľký vypínač	-	-	-	-	-	-
GA7040R	GA9040R	2 600 W	Veľký vypínač	-	●	-	●	●	-
GA7040S	GA9040S	2 600 W	Veľký vypínač	-	-	-	●	●	-
-	GA9040	2 600 W	Veľký vypínač	-	-	-	●	-	-
GA7030R	GA9030R	2 400 W	Veľký vypínač	-	●	-	●	●	-
GA7030S / GA7030	GA9030S / GA9030	2 400 W	Veľký vypínač	-	-	-	●	● / -	-
GA7031	GA9031	2 400 W	AC/DC trigger	-	-	-	●	-	-
GA7061R / GA7063R	GA9061R / GA9063R	2 200 W	Veľký vypínač	-	-	-	-	●	-
GA7061	GA9061	2 200 W	Veľký vypínač	●	-	-	-	-	-
GA7060R / GA7062R	GA9060R / GA9062R	2 200 W	Veľký vypínač	-	●	-	-	●	-
GA7060 / GA7062 / GA7064	GA9060 / GA9062	2 200 W	Veľký vypínač	-	-	-	-	-	-
GA7020R	GA9020R	2 200 W	Veľký vypínač	-	●	-	-	●	-
GA7020S	GA9020S	2 200 W	Veľký vypínač	-	-	-	-	●	-
GA7020	-	2 200 W	Veľký vypínač	-	-	-	-	-	-
GA7050 / GA7050R	GA9050 / GA9050R	2 000 W	Veľký vypínač	-	- / ●	-	-	- / ●	-
GA7012C	GA9012C	1 800 W	Veľký vypínač	-	●	●	-	●	-
GA7010C	GA9010C	1 800 W	Veľký vypínač	-	-	●	-	●	-

 Brúsenie  
Leštenie



Prikon	900 W
Max. priemer padu	Pad: 180 mm
Voľnobežné otáčky	600 – 2.100
Vibrácie	Leštenie: 2,5 m/s <sup>2</sup>
Úroveň akustického tlaku	81 dB(A)
Úroveň akustického výkonu	92 dB(A)
Celková dĺžka	210 mm
Hmotnosť	2,1 kg
Dĺžka privodného kábla	2,5 m



**PV7000C**  
**249,99 €**



Prikon	1.400 W
Priemer kotúča	125 mm
Vrtanie brúsneho kotúča	22,23 mm
Voľnobežné otáčky	10.000
Rozmery	437×235×195 mm
Hmotnosť	4 kg
Dĺžka privodného kábla	5,0 m



**PC5000C**  
**497,99 €**



Prikon	1.400 W
Priemer kotúča	125 mm
Vrtanie brúsneho kotúča	22,23 mm
Voľnobežné otáčky	4.000 – 9.000
Rozmery	350×231×179 mm
Hmotnosť	2,5 – 3,6 kg
Dĺžka privodného kábla	4,0 m



**PC5010C**  
**378,99 €**

**SJST**  
SUPER JOINT SYSTEM



Prikon	240 W
Uchytenie nástroja	Klieština: 6 mm
Max. priemer brúsneho nástroja	19 mm
Voľnobežné otáčky	28.000
Priemer rukoväti	65 mm
Rozmery	289×64×67 mm
Hmotnosť	0,98 kg
Dĺžka privodného kábla	2,5 m



**GD0603**  
**93,99 €**



Prikon	400 W
Uchytenie nástroja	Klieština: 3, 6 mm
Priemer kotúča	38 mm
Voľnobežné otáčky	25.000
Rozmery	359×82×82 mm
Hmotnosť	1,68 – 1,84 kg
Dĺžka privodného kábla	2,5 m



**GD0601**  
**103,99 €**



## Priama brúska

GD0801C 8 mm

318 

Stroj je dodávaný bez brúsneho nástroja



Prikon	750 W
Uchytenie nástroja	Klieština: 8 mm
Max. priemer brúsneho nástroja	25 mm
Voľnobežné otáčky	7.000 – 29.000
Vibrácie	Plôšné brúsenie: 3,5 m/s <sup>2</sup>
Úroveň akustického tlaku	80 dB(A)
Úroveň akustického výkonu	91 dB(A)
Rozmery	390×75×88 mm
Hmotnosť	1,96 – 1,97 kg
Dĺžka prívodného kábla	2,5 m

**GD0801C**  
**346,99 €**

## Priama brúska

GD0800C 8 mm

318 

Stroj je dodávaný bez brúsneho nástroja



Prikon	750 W
Uchytenie nástroja	Klieština: 3, 6, 8 mm
Priemer kotúča	25 mm
Voľnobežné otáčky	7.000 – 28.000
Rozmery	371×75×75 mm
Hmotnosť	1,88 kg
Dĺžka prívodného kábla	2,5 m

**GD0800C**  
**311,99 €**

## Priama brúska

GD0810C 8 mm

318 

Stroj je dodávaný bez brúsneho nástroja



Prikon	750 W
Uchytenie nástroja	Klieština: 3, 6, 8 mm
Priemer kotúča	50 mm
Voľnobežné otáčky	1.800 – 7.000
Celková dĺžka	371 mm
Hmotnosť	1,9 kg
Dĺžka prívodného kábla	2,5 m

**GD0810C**  
**324,99 €**

## Multifunkčné náradie

TM3010C

459 

Prikon	320 W
Počet strihov za minútu	6.000 – 20.000
Rozmery	283×68×87 mm
Hmotnosť	1,6 – 1,7 kg
Dĺžka prívodného kábla	2,5 m

**TM3010C**  
**185,99 €**
**TM3010CX5J**  
**279,99 €**

X5 – sada príslušenstva

## Kotúčová brúska

GB602 150 mm



Prikon	250 W
Priemer kotúča	150 mm
Hrúbka kotúča	16 mm
Vítanie brúsneho kotúča	12,7 mm
Voľnobežné otáčky	2.850 (50 Hz) / 3.450 (60 Hz)
Úroveň akustického tlaku	74 dB(A)
Rozmery	375×205×286 mm
Hmotnosť	9,31 – 9,08 kg

**GB602**  
**191,99 €**

## Kotúčová brúska

GB602W 150 mm



Prikon	250 W
Priemer kotúča	150 mm
Hrúbka kotúča	6,4 mm / 16 mm
Vítanie brúsneho kotúča	12,7 mm
Voľnobežné otáčky	2.850 (50 Hz) / 3.450 (60 Hz)
Úroveň akustického tlaku	75 dB(A)
Rozmery	375×348×286 mm
Hmotnosť	9,27 – 8,93 kg

**GB602W**  
**189,99 €**

## Kotúčová brúska

GB801 205 mm



Prikon	550 W
Priemer kotúča	205 mm
Hrúbka kotúča	19 mm
Vítanie brúsneho kotúča	15,88 mm
Voľnobežné otáčky	2.850 (50 Hz) / 3.450 (60 Hz)
Úroveň akustického tlaku	77 dB(A)
Rozmery	395×265×333 mm
Hmotnosť	19,91 – 19,63 kg

**GB801**  
**299,99 €**

## Pásová brúska

9032 9 mm × 533 mm

411



Prikon	500 W
Rozmer brúsneho pásu	9×533 mm
Rýchlosť brúsneho pásu	300 – 1.700 m/min
Max. hĺbka brúsenia	110 mm
Celková dĺžka	420 mm
Hmotnosť	1,6 kg
Dĺžka prívodného kábla	2,5 m

**9032**  
**259,99 €**

## Pásová brúska

9031 30 mm × 533 mm

411



Prikon	550 W
Rozmer brúsneho pásu	30×533 mm
Rýchlosť brúsneho pásu	200 – 1.000 m/min
Celková dĺžka	380 mm
Hmotnosť	2,1 kg
Dĺžka prívodného kábla	2,5 m

**9031**  
**324,99 €**

## Pásová brúska

9911 / 9910 76 mm × 457 mm

411



	9911	9910
Prikon	650 W	650 W
Rozmer brúsneho pásu	76×457 mm	76×457 mm
Rýchlosť brúsneho pásu	75 – 270 m/min	270 m/min
Celková dĺžka	262 mm	262 mm
Hmotnosť	2,7 kg	2,7 kg
Dĺžka prívodného kábla	2,5 m	2,5 m



9911

**9911**  
**184,99 €**
**9910**  
**162,99 €**

## Pásová brúska

9903 76 mm × 533 mm

303 

Príkion	1,010 W
Rozmer brúsneho pásu	76×533 mm
Rýchlosť brúsneho pásu	210 – 440 m/min
Celková dĺžka	296 mm
Hmotnosť	4,3 kg
Dĺžka prívodného kábla	5,0 m

**9903**  
**314,99 €**

## Pásová brúska

9924DB 76 mm × 610 mm

100 

Príkion	850 W
Rozmer brúsneho pásu	76×610, 620 mm
Rýchlosť brúsneho pásu	400 m/min
Celková dĺžka	355 mm
Hmotnosť	4,8 kg
Dĺžka prívodného kábla	5,0 m

**9924DB**  
**324,99 €**

## Pásová brúska

9403 100 mm × 610 mm

303 

Príkion	1,200 W
Rozmer brúsneho pásu	100×610 mm
Rýchlosť brúsneho pásu	500 m/min
Celková dĺžka	353 mm
Hmotnosť	5,7 kg
Dĺžka prívodného kábla	5,0 m

**9403J**  
**374,99 €**

## Pásová brúska

9404 100 mm × 610 mm

303 

Príkion	1,010 W
Rozmer brúsneho pásu	100×610 mm
Rýchlosť brúsneho pásu	210 – 440 m/min
Celková dĺžka	334 mm
Hmotnosť	4,8 kg
Dĺžka prívodného kábla	5,0 m

**9404J**  
**395,99 €**

## Kefová brúska

9741

100 

Príkion	860 W
Priemer kotúča	100×120 mm
Voľnobežné otáčky	3,500
Celková dĺžka	310 mm
Hmotnosť	4,2 kg
Dĺžka prívodného kábla	5,0 m

**9741**  
**574,99 €**



Vibračná brúska

B03711 / B03710

64 



	B03711	B03710
Prikon	190 W	190 W
Rozmer padu	93×185 mm	93×185 mm
Rozmer brúsneho papiera	93×228 mm	93×228 mm
Excentrický výkyv za minútu	4.000 – 11.000	11.000
Počet strihov za minútu	8.000 – 22.000	22.000
Priemer výkyvu	2,0 mm	2,0 mm
Vibrácie	Brúsenie železnej platne: 3,5 m/s <sup>2</sup>	Brúsenie železnej platne: 3,5 m/s <sup>2</sup>
Úroveň akustického tlaku	72 dB(A)	72 dB(A)
Rozmery	253×92×154 mm	253×92×154 mm
Hmotnosť	1,6 kg	1,6 kg
Dĺžka privodného kábla	2,0 m	2,0 m



B03711

**B03711**  
108,99 €

**B03710**  
97,99 €

Vibračná brúska

B04900V

419 



Prikon	330 W
Rozmer padu	115×229 mm
Rozmer brúsneho papiera	115×232 mm
Excentrický výkyv za minútu	4.000 – 10.000
Celková dĺžka	289 mm
Hmotnosť	2,9 kg
Dĺžka privodného kábla	2,5 m



**B04900VJ**  
324,99 €

Vibračná brúska

9046

419 



Prikon	600 W
Rozmer padu	115×229 mm
Rozmer brúsneho papiera	115×280 mm
Excentrický výkyv za minútu	6.000
Celková dĺžka	283 mm
Priemer výkyvu	5 mm
Hmotnosť	3,1 kg
Dĺžka privodného kábla	2,5 m



**9046**  
279,99 €

Vibračná brúska

B04555

419 



Prikon	200 W
Rozmer padu	112×102 mm
Rozmer brúsneho papiera	114×102 mm
Excentrický výkyv za minútu	14.000
Celková dĺžka	131×112×141 mm
Hmotnosť	1,1 kg
Dĺžka privodného kábla	2,0 m



**B04555**  
97,99 €

Vibračná brúska

B04565

419 



Prikon	200 W
Rozmer padu	112×190 mm
Rozmer brúsneho papiera	114×102 mm
Trojuholník	96 mm
Excentrický výkyv za minútu	14.000
Rozmery	219×112×139 mm
Hmotnosť	1,2 kg
Dĺžka privodného kábla	2,0 m



**B04565K**  
108,99 €

## Vibračná brúška

BO4557

419 

Príkon	180 W
Rozmer padu	112x102 mm
Rozmer brúsneho papiera	114x140 mm
Excentrický výkyv za minútu	14.000
Rozmery	131x112x137 mm
Hmotnosť	1 kg
Dĺžka privodného kábla	2,0 m

**BO4557**  
**75,99 €**

## Excentrická brúška

BO5031 / BO5030 125 mm

419 

	BO5031	BO5030
Príkon	300 W	300 W
Priemer padu	123 mm	123 mm
Priemer brúsneho kotúča	125 mm	125 mm
Excentrický výkyv za minútu	4.000 – 12.000	12.000
Rozmery	153x123x153 mm	153x123x153 mm
Hmotnosť	1,3 kg	1,3 kg
Dĺžka privodného kábla	2,0 m	2,0 m



BO5031

**BO5031**  
**139,99 €**
**BO5030**  
**119,99 €**

## Excentrická brúška

BO5041 125 mm

64 

Príkon	300 W
Rozmer padu	123 mm
Rozmer brúsneho papiera	125 mm
Excentrický výkyv za minútu	4.000 – 12.000
Rozmery	218x123x153 mm
Hmotnosť	1,4 kg
Dĺžka privodného kábla	2,0 m

**BO5041**  
**176,99 €**

## Excentrická brúška

BO6030 150 mm

419 

Príkon	310 W
Rozmer padu	150 mm
Rozmer brúsneho papiera	150 mm
Excentrický výkyv za minútu	4.000 – 10.000
Celková dĺžka	309 mm
Priemer výkyvu	3,0 mm
Hmotnosť	2,4 kg
Dĺžka privodného kábla	2,5 m

**BO6030**  
**249,99 €**

## Excentrická brúška

BO6050 150 mm

















326 

Príkon	750 W
Rozmer padu / brúsneho papiera	150 mm / 150 mm
Excentrický výkyv za minútu	1.600 – 6.800
Počet kmitov za minútu	3.200 – 13.600
Rýchlosť padu v roto-orbit móde	140 – 600
Priemer výkyvu	5,5 mm
Vibrácie	Sanding Metal Plate: 5,0 m/s <sup>2</sup> Leštenie: 3,0 m/s <sup>2</sup>
Úroveň akustického tlaku	82 dB(A)
Úroveň akustického výkonu	93 dB(A)
Rozmery	330x155x145 mm
Hmotnosť	2,6 kg
Dĺžka privodného kábla	2,5 m

**BO6050J**  
**465,99 €**

# ▣ PÍLENIE



-  Dvojitá izolácia
-  Nastavenie otáčok
-  Brzda
-  Mechanické nastavenie otáčok / 2 rýchlosti/
-  Konštantné otáčky
-  Obmedzovač rozbehového prúdu
-  Rez pod uhlom 45 LR
-  Rez pod uhlom L45 R5
-  Rez pod uhlom 45 vľavo
-  Rez v oblúku
-  Makita uchytenie nástroja
-  Bajonetové upínanie
-  Laser
-  Odsávanie prachu
-  Zabudované osvetlenie
-  Prepravný kufr



## Pokosová píla

LS1219L 305 mm

153



Príkon	1.800 W
Priemer rezného kotúča	305 mm
Max. uhol pokosu	60° L / 60° R
Max. uhol úkosu	48° L / 48° R
Max. rezný výkon	90°: 107×363 mm 45°: 107×255 mm
Voľnobežné otáčky	3.200
Rozmery	898×644×725 mm
Hmotnosť	LS1219L: 29,3 kg
Dĺžka prívodného kábla	2,5 m

**DXT**  
 Deep and Exact Cutting Technology

**LS1219L**  
**973,99 €**

## Pokosová píla

LS1019L 260 mm

153



Príkon	1.510 W
Priemer rezného kotúča	260 mm
Max. uhol pokosu	48° L / 48° R
Max. uhol úkosu	60° L / 60° R
Max. rezný výkon (pokos / úkos)	90°/90°: 68 / 310 mm 90°/90°: 91 / 279 mm 90°/45°LR: 68 / 218 mm 90°/45°LR: 91 / 197 mm
Voľnobežné otáčky	3.200
Úroveň akustického tlaku	91 dB(A)
Úroveň akustického výkonu	101 dB(A)
Vibrácie	2,5 m/s <sup>2</sup>
Rozmery	805×644×660 mm
Hmotnosť	LS1019L: 26,3 kg

**DXT**  
 Deep and Exact Cutting Technology

**LS1019L**  
**831,99 €**

## Pokosová píla

LS1018LN 260 mm

JM23000123



Príkon	1.430 W
Priemer rezného kotúča	255 - 260 mm
Max. uhol pokosu	47° L / 60° R
Max. uhol úkosu	45° L / 45° R
Max. rezný výkon	90°: 91×305 mm 45°: 91×215 mm
Voľnobežné otáčky	4.300
Úroveň akustického tlaku	97 dB(A)
Úroveň akustického výkonu	103 dB(A)
Vibrácie	2,5 m/s <sup>2</sup>
Rozmery	825×536×633 mm
Hmotnosť	20,6 kg
Dĺžka prívodného kábla	2,5 m

**LS1018LN**  
**624,99 €**

## Pokosová píla

LS0815FLN 216 mm

JM23500117



Príkon	1.400 W
Priemer rezného kotúča	216 mm
Max. uhol pokosu	50° L / 60° R
Max. uhol úkosu	48° L / 5° R
Max. rezný výkon	90° Pokos: 65×305 mm 45° Pokos. L/R: 65×215 mm
Voľnobežné otáčky	5.000
Úroveň akustického tlaku	87 dB(A)
Úroveň akustického výkonu	110 dB(A)
Vibrácie	2,5 m/s <sup>2</sup>
Rozmery	755×450×488 mm
Hmotnosť	14,1 kg
Dĺžka prívodného kábla	2,5 m

**LS0815FLN**  
**459,99 €**

## Pokosová píla

LS0714N 190 mm

153



Príkon	1.010 W
Priemer rezného kotúča	190 mm
Max. uhol pokosu	47° L / 57° R
Max. uhol úkosu	45° L / 5° R
Max. rezný výkon	90°: 52×300 mm 45°: 52×212 mm
Voľnobežné otáčky	6.000
Úroveň akustického tlaku	92 dB(A)
Úroveň akustického výkonu	101 dB(A)
Vibrácie	2,5 m/s <sup>2</sup>
Rozmery	670×430×458 mm
Hmotnosť	13,1 kg
Dĺžka prívodného kábla	2,5 m

**LS0714N**  
**559,99 €**



Prikon	1.650 W
Priemer rezného kotúča	260 mm
Max. uhol pokosu	45° L / 52° R
Max. uhol úkosu	45° L
Max. rezný výkon	90°: 90,5×95 mm 45°: 90,5×67 mm
Voľnobežné otáčky / min <sup>-1</sup>	4.600
Úroveň akustického tlaku	93 dB(A)
Úroveň akustického výkonu	106 dB(A)
Rozmery	530×476×532 mm
Hmotnosť	12,4 kg
Dĺžka privodného kábla	2,5 m

**LS1040N**  
**337,99 €**



Prikon	1.650 W
Priemer rezného kotúča	305 mm
Max. uhol pokosu	47° L / 52° R
Max. uhol úkosu	45° L
Max. rezný výkon	90°: 62×200 mm 90°: 95×155 mm 90°: Table sa W: 52 mm
Voľnobežné otáčky	3.800
Úroveň akustického tlaku	93 dB(A)
Úroveň akustického výkonu	106 dB(A)
Veľkosť stola	307×465 mm
Rozmery	610×535×692 mm
Hmotnosť	20,9 kg
Dĺžka privodného kábla	2,5 m

**LH1201FL**  
**719,99 €**



Prikon	1.650 W
Max. rezný výkon	90°: 93×95 mm 45°: 53×95 mm
Priemer rezného kotúča	260 mm
Voľnobežné otáčky	4.800
Rozmery	530×476×535 mm
Hmotnosť	14,3 kg
Dĺžka privodného kábla	2,5 m

**LH1040**  
**525,99 €**



Prikon	1.650 W
Max. rezný výkon	90°: 20×210 mm 90°: 68×155 mm 45°: 50×150 mm
Priemer rezného kotúča	260 mm
Voľnobežné otáčky	2.700
Rozmery	Pokosová píla: 660×650×1.220 mm Stolová píla: 660×650×1.060 mm
Hmotnosť	36,0 kg
Dĺžka privodného kábla	2,5 m

**LF1000**  
**1 253,99 €**



Prikon	2.000 W
Max. rezný výkon	90°: 85 mm 45°: 58 mm
Priemer rezného kotúča	315 mm
Voľnobežné otáčky	50 Hz: 2.950 60 Hz: 3.400
Max. rezný výkon / úkos/	0 – 45
Rozmery	1.670×700×810 mm
Hmotnosť	54 kg
Dĺžka privodného kábla	3,0 m

**2712**  
**519,99 €**



## Stolová píla

2704 260 mm

153 

Príkon	1.650 W
Max. rezný výkon	90°: 93 mm
	45°: 64 mm
Priemer rezného kotúča	260 mm
Voľnobežné otáčky	4.800
Max. rezný výkon /úkos/	- 0,5 - 45,5
Rozmery	665x766x344 mm
Hmotnosť	35,6 - 37,3 kg
Dĺžka privodného kábla	2,5 m

**2704N**  
**1 189,99 €**

## Stolová píla

MLT100N 260 mm

JM23000123 

Príkon	1.500 W
Max. rezný výkon	90°: 91 mm
	45°: 63 mm
Priemer rezného kotúča	260 mm
Voľnobežné otáčky	4.300
Rozmery	726x984x333 mm
Hmotnosť	34,1 kg
Dĺžka privodného kábla	2,5 m

**MLT100N**  
**825,99 €**

## Pokosová píla

MLS100N 255 mm



Príkon	1.500 W
Priemer rezného kotúča	255 mm
Max. uhol pokosu	75x130 mm
Max. uhol úkosu	75x90 mm
Voľnobežné otáčky / min <sup>-1</sup>	4.200
Hmotnosť	14,7 kg

**MLS100N**  
**363,99 €**

## Kotúčová píla

HS6101 165 mm

174 

Príkon	1.100 W
Priemer rezného kotúča	165 mm
Max. rezný výkon	90°: 54,5 mm
	45°: 39,5 mm
	50°: 35,5 mm
Voľnobežné otáčky	5.500
Rozmery	297x246x246 mm
Hmotnosť	3,5 kg
Dĺžka privodného kábla	2,5 m
Pripojenie na lištu s adaptérom	195838-7
	197252-3

**HS6101J**  
**291,99 €**

## Kotúčová píla

HS6601 165 mm

303 

Príkon	1.050 W
Priemer rezného kotúča	165 mm
Max. rezný výkon	90°: 54,5 mm
	45°: 37,5 mm
Voľnobežné otáčky	5.200
Vibrácie	Rezanie dreva
	2,5 m/s <sup>2</sup>
Úroveň akustického tlaku	87 dB(A)
Úroveň akustického výkonu	98 dB(A)
Rozmery	296x232x243 mm
Hmotnosť	3,4 kg
Dĺžka privodného kábla	2,5 m



Pripojenie na lištu s adaptérom 197462-2

**HS6601**  
**139,99 €**
**HS6601J**  
**193,99 €**



## Kotúčová píla

HS7611 185 mm / 190 mm

174



Prikon	1.600 W
Priemer rezného kotúča	185 / 190 mm
Max. rezný výkon	90°: 63 / 65 mm
	45°: 44 / 45 mm
Voľnobežné otáčky	5.500
Rozmery	311×240×261 mm
Hmotnosť	3,9 kg
Dĺžka prívodného kábla	2,5 m

Pripojenie na lištu s adaptérom 197005-0



**HS7611J**  
205,99 €

## Kotúčová píla

HS7101 / HS7100 190 mm

174



Prikon	1.400 W
Priemer rezného kotúča	190 mm
Max. rezný výkon	90°: 67 mm
	45°: 48,5 mm
	50°: 43,5 mm
Voľnobežné otáčky	5.500
Rozmery	310×246×258 mm
Hmotnosť	HS7101: 3,8 kg
	HS7100: 3,7 kg
Dĺžka prívodného kábla	2,5 m

Pripojenie na lištu s adaptérom 195837-9  
197252-3



HS7101 HS7101

**HS7101**  
259,99 €

**HS7100**  
216,99 €

## Kotúčová píla

HS7601 190 mm

303



Prikon	1.200 W
Priemer rezného kotúča	190 mm
Max. rezný výkon	90°: 66 mm
	45°: 46 mm
Voľnobežné otáčky	5.200
Rozmery	309×232×255 mm
Hmotnosť	3,8 kg
Dĺžka prívodného kábla	2,5 m

Pripojenie na lištu s adaptérom 197005-0



**HS7601**  
173,99 €

## Kotúčová píla

5903R 235 mm

203



Prikon	2.000 W
Max. rezný výkon	90°: 85 mm
	45°: 64 mm
Priemer rezného kotúča	235 mm
Voľnobežné otáčky	4.500
Celková dĺžka	400 mm
Hmotnosť	7,2 kg
Dĺžka prívodného kábla	2,5 m

Pripojenie na lištu s adaptérom 192506-3



**5903R**  
301,99 €

## Kotúčová píla

N5900B 235 mm

153



Prikon	2.000 W
Priemer rezného kotúča	235 mm
Max. rezný výkon	90°: 85 mm
	45°: 60 mm
	50°: 53 mm
Voľnobežné otáčky	4.100
Celková dĺžka	380 mm
Hmotnosť	6,8 kg
Dĺžka prívodného kábla	2,5 m

Pripojenie na lištu nie



**N5900B**  
205,99 €

## Kotúčová píla

5103R 270 mm

203



Príkon	2.100 W
Max. rezný výkon	90°: 100 mm 45°: 73 mm
Priemer rezného kotúča	270 mm
Voľnobežné otáčky	3.800
Celková dĺžka	442 mm
Hmotnosť	9,3 kg
Dĺžka privodného kábla	2,5 m
Pripojenie na lištu s adaptérom	192507-1

**5103R**  
**648,99 €**

## Kotúčová píla

HS0600 260 mm / 270 mm

153



Príkon	2.000 W
Priemer rezného kotúča	260 / 270 mm
Max. rezný výkon	90°: 97 / 101 mm 45°: 68 / 71 mm 50°: 61 / 63 mm
Voľnobežné otáčky	4.300
Vibrácie	Rezanie dreva: 2,5 m/s <sup>2</sup>
Úroveň akustického tlaku	94 dB(A)
Úroveň akustického výkonu	105 dB(A)
Rozmery	418x273x324 mm
Hmotnosť	6,9 kg
Dĺžka privodného kábla	2,5 m
Pripojenie na lištu s adaptérom	198570-2

**HS0600**  
**311,99 €**

## Kotúčová píla

5143R 355 mm

203



Príkon	2.200 W
Priemer rezného kotúča	355 mm
Max. rezný výkon	90°: 130 mm 45°: 90 mm
Voľnobežné otáčky	2.700
Celková dĺžka	607 mm
Hmotnosť	12,5 kg
Dĺžka privodného kábla	5,0 m
Pripojenie na lištu	nie

**5143R**  
**973,99 €**

## Ponorná píla

SP6000 165 mm

303



Príkon	1.300 W
Priemer rezného kotúča	165 mm
Max. rezný výkon	90°: 56 mm 45°: 40 mm 48°: 38 mm
Voľnobežné otáčky	2.000 – 5.800
Rozmery	341x225x250 mm
Hmotnosť	4,1 kg
Dĺžka privodného kábla	2,5 m
Pripojenie na lištu bez adaptéru	áno

**SP6000J**  
**432,99 €**

## Priamočiara píla

4350FCT

419



Príkon	720 W
Max. rezný výkon	Drevo: 135 mm Železo: 10 mm
Dĺžka kmitu	26 mm
Kmity / min	800 – 2.800
Rozmery	236x73x207 mm
Hmotnosť	2,7 kg
Dĺžka privodného kábla	2,5 m

**4350FCTJ**  
**249,99 €**

**Priamočiara píla**

**4351FCT**

419 



Prikon	720 W
Max. rezný výkon	Drevo: 135 mm Železo: 10 mm
Dĺžka kmitu	26 mm
Kmity / min	800 – 2.800
Rozmery	271×73×187 mm
Hmotnosť	2,6 kg
Dĺžka privodného kábla	2,5 m



**4351FCTJ**  
**239,99 €**

**Priamočiara píla**

**JV0600**

64 



Prikon	650 W
Max. rezný výkon	Drevo: 90 mm Železo: 10 mm
Dĺžka kmitu	23 mm
Kmity / min	500 – 3.100
Rozmery	236×77×199 mm
Hmotnosť	2,4 kg
Dĺžka privodného kábla	2,5 m



**JV0600K**  
**141,99 €**

**Priamočiara píla**

**4329**

64 



Prikon	450 W
Max. rezný výkon pri 90°	Drevo: 65 mm Železo: 6 mm
Dĺžka kmitu	18 mm
Kmity / min	500 – 3.100
Vibrácie	Rezanie dreva: 7,0 m/s <sup>2</sup> Rezanie železných platní: 5,0 m/s <sup>2</sup>
Úroveň akustického tlaku	83 dB(A)
Úroveň akustického výkonu	94 dB(A)
Rozmery	223×77×197 mm
Hmotnosť	1,9 kg
Dĺžka privodného kábla	2,0 m



**4329**  
**97,99 €**

**Priamočiara píla**

**4327 / 4326**

64 



	4327	4326
Prikon	450 W	450 W
Max. rezný výkon	Drevo: 65 mm Železo: 6 mm	Drevo: 65 mm Železo: 6 mm
Dĺžka kmitu	18 mm	18 mm
Kmity / min	500 – 3.100	3.100
Rozmery	224×77×197 mm	224×77×197 mm
Hmotnosť	1,9 kg	1,9 kg
Dĺžka privodného kábla	2,0 m	2,0 m



4327

**4327**  
**87,99 €**

**4326**  
**83,99 €**

**Chvostová píla**

**JR3051TK**

419 



Prikon	1.200 W
Dĺžka kmitu	30 mm
Kmity / min	0 – 3.000
Max. rezný výkon	Rúra: 130 mm Drevo: 255 mm
Rozmery	447×97×176 mm
Hmotnosť	3,2 – 3,3 kg
Dĺžka privodného kábla	2,5 m



**JR3051TK**  
**173,99 €**



## Chvostová píla

JR3061T

303 

Príkon	1.250 W
Dĺžka kmitu	32 mm
Kmity / min	0 – 3,000
Max. rezný výkon	Rúra 130 mm
	Drevo 255 mm
Vibrácie	Rezanie drevených platní: 16,5 m/s <sup>2</sup>
Úroveň akustického tlaku	88 dB(A)
Úroveň akustického výkonu	99 dB(A)
Rozmery	487x95x177 mm
Hmotnosť	3,8 kg
Dĺžka privodného kábla	2,5 m

**JR3061T**  
**218,99 €**

## Chvostová píla

JR3070CT

303 

Príkon	1.510 W
Dĺžka kmitu	32 mm
Kmity / min	0 – 2.800
Max. rezný výkon	Rúra: 130 mm
	Drevo: 255 mm
Vibrácie	Drevené platne: 9,5 m/s <sup>2</sup>
	Drevené hrady: 10,5 m/s <sup>2</sup>
Úroveň akustického tlaku	89 dB(A)
Úroveň akustického výkonu	100 dB(A)
Celková dĺžka	485 mm
Hmotnosť	4,6 kg
Dĺžka privodného kábla	2,5 m

**AVT**  
 ANTI VIBRATION TECHNOLOGY

**JR3070CT**  
**311,99 €**

## Pásová píla

LB1200F











Príkon	900 W
Max. rezný výkon	Hrúbka rezu: 165 mm
Rýchlosť rezného pásu	Max.: (50 Hz)800 (60 Hz)1.000 m / min
	Min.: (50 Hz)400 (60 Hz)500 m / min
Rozmery	615x775x1.600 mm
Hmotnosť	82 kg
Dĺžka privodného kábla	2,5 m

**LB1200F**  
**957,99 €**

# □ HOBĽOVANIE / FRÉZOVANIE



-  Dvojitá izolácia
-  Nastavenie otáčok
-  Brzda
-  Konštantné otáčky
-  Obmedzovač rozbehového prúdu
-  Odsávanie prachu
-  Zabudované osvetlenie
-  Drevený prepravný kufor
-  Prepravný kufor



## Hoblík

1806B 170 mm



Príkon	1.200 W
Sírka noža	170 mm
Max. hĺbka	0 – 2 mm
Voľnobežné otáčky	15.000
Rozmery	530x240x150 mm
Hmotnosť	9 kg

**1806B**  
**748,99 €**

## Hoblík

KP0810C 82 mm

132



Príkon	1.050 W
Sírka noža	82 mm
Max. hĺbka	4 mm
Max. drážka	25 mm
Voľnobežné otáčky	12.000
Rozmery	290x168x176 mm
Hmotnosť	3,4 kg
Dĺžka privodného kábla	2,5 m

**KP0810C**  
**311,99 €**

## Hoblík

KP0810 82 mm

132



Príkon	850 W
Sírka noža	82 mm
Max. hĺbka	4 mm
Max. drážka	25 mm
Voľnobežné otáčky	16.000
Rozmery	290x168x176 mm
Hmotnosť	3,3 kg
Dĺžka privodného kábla	2,5 m

**KP0810**  
**291,99 €**

## Hoblík

KP0800 82 mm

411



Príkon	620 W
Sírka noža	82 mm
Max. hĺbka	2,5 mm
Voľnobežné otáčky	17.000
Rozmery	285x158x158 mm
Hmotnosť	2,8 kg
Dĺžka privodného kábla	2,5 m

**KP0800**  
**162,99 €**

## Hoblík

1911B 110 mm

106



Príkon	840 W
Sírka noža	110 mm
Max. hĺbka	2 mm
Voľnobežné otáčky	16.000
Celková dĺžka	355 mm
Hmotnosť	4,1 kg
Dĺžka privodného kábla	5,0 m

**1911B**  
**311,99 €**





Prikon	2.200 W
Šírka noža	312 mm
Max. hĺbka	Rezná šírka 0 – 150 mm : 3,5 mm Rezná šírka 150 – 240 mm : 2,0 mm Rezná šírka 240 – 312 mm : 1,5 mm
Voľnobežné otáčky	12.000
Celková dĺžka	551 mm
Hmotnosť	18,4 kg
Dĺžka prívodného kábla	10 m



**KP312S**  
**2 589,99 €**



Prikon	1.650 W
Šírka noža	304 mm
Max. hĺbka	Rezná šírka 0 – 150 mm : 3 mm Rezná šírka 150 – 240 mm : 1,5 mm
Max. rýchlosť hobľovania /min/	8,5 m
Veľkosť stola	304×771 mm
Voľnobežné otáčky	8.500
Rozmery	483×771×401 mm
Hmotnosť	27,1 – 27,6 kg
Dĺžka prívodného kábla	2,5 m



**2012NBX**  
**914,99 €**

X – stôl



Prikon	701 W
Priemer rezného kotúča	100 mm
Voľnobežné otáčky	11.000
Rozmery	302×139×145 mm
Hmotnosť	2,8 kg
Dĺžka prívodného kábla	2,5 m



**PJ7000J**  
**395,99 €**



Prikon	710 W
Upínacia klieština	6, 8 mm
Voľnobežné otáčky	10.000 – 34.000
Rozmery	89×89×210 mm
Hmotnosť	1,8 – 2,8 kg



**RT0702C**  
**166,99 €**

**RT0702CX2J**  
**269,99 €**

X2 – ponorný nadstavec, frézovací nadstavec



Prikon	530 W
Upínacia klieština	6 mm
Voľnobežné otáčky	32.000
Vibrácie	2,5 m/s <sup>2</sup>
Úroveň akustického tlaku	94 dB(A)
Úroveň akustického výkonu	83 dB(A)
Rozmery	82×90×211 mm
Hmotnosť	1,5 kg
Dĺžka prívodného kábla	2,5 m



**3711**  
**103,99 €**

## Jednoručná fréza

3712 6 mm

NOVINKA

411



Príkon	530 W
Upínacia klieština	6 mm
Voľnobežné otáčky	32,000
Vibrácie	2,5 m/s <sup>2</sup>
Úroveň akustického tlaku	94 dB(A)
Úroveň akustického výkonu	83 dB(A)
Rozmery	82×90×211 mm
Hmotnosť	1,5 kg
Dĺžka privodného kábla	2,5 m



**3712**  
**119,99 €**

## Horná fréza

RP1111C 8 mm

NOVINKA

411



Príkon	1.100 W
Max. hĺbka ponoru	0 – 57 mm
Voľnobežné otáčky	8.000 – 27.500
Klieština	8 mm
Rozmery	110×269×260 mm
Hmotnosť	3,3 kg
Dĺžka privodného kábla	4 m

Pripojenie na lištu s adaptérom 194579-2



**RP1111CJ**  
**378,99 €**

## Horná fréza

RP0900 6 mm, 8 mm

106



Príkon	900 W
Max. hĺbka ponoru	0 – 35 mm
Voľnobežné otáčky	27.000
Vibrácie	Rez drážok v MDF: 4,0 m/s <sup>2</sup>
Úroveň akustického tlaku	89 dB(A)
Úroveň akustického výkonu	100 dB(A)
Rozmery	110×256×217 mm
Hmotnosť	2,7 kg
Dĺžka privodného kábla	2,5 m

Pripojenie na lištu s adaptérom 194579-2



**RP0900**  
**155,99 €**

## Horná fréza

RP2303FC 12 mm

NOVINKA

203



Príkon	2.100 W
Upínacia klieština	12 mm
Max. hĺbka ponoru	0 – 70 mm
Voľnobežné otáčky	9.000 – 23.000
Rozmery	155×294×327 mm
Hmotnosť	6,2 kg
Dĺžka privodného kábla	4,0 m

Pripojenie na lištu s adaptérom 194579-2



**RP2303FCXJ**  
**562,99 €**

## Horná fréza

RP1803F 12 mm

NOVINKA

203



Príkon	1.650 W
Upínacia klieština	12 mm
Max. hĺbka ponoru	0 – 70 mm
Voľnobežné otáčky	22.000
Rozmery	155×294×312 mm
Hmotnosť	6,2 kg
Dĺžka privodného kábla	4,0 m

Pripojenie na lištu s adaptérom 194579-2



**RP1803FXJ**  
**476,99 €**



Prikon	1.140 W
Max. výkon	Max. šírka: 130 mm
	Max. hĺbka: 155 mm
Voľnobežné otáčky	3.200
Rozmery	512x298x513 mm
Hmotnosť	17,8 – 18,2 kg
Dĺžka privodného kábla	5,0 m

**7104L**  
**1 871,99 €**



Prikon	2.000 W
Max. hĺbka drážky	100 mm
Voľnobežné otáčky	4.500
Hmotnosť	12,8 kg







**KC100**  
**2 495,99 €**





# ▣ ODSÁVANIE



-  Dvojitá izolácia
-  Nastavenie otáčok
-  Nerezová zberná nádoba
-  Flexibilná hadica
-  Antistatická hadica

**Vysávač**

**VC4210L / VC4210M** /mokré & suché vysávanie/

325



EU trieda prašnosti	L / M
Príkon	1.400 W
Max. prietok vzduchu	4,5 m <sup>3</sup> /min
Max. podtlak	25,0kPa
Objem nádrže	Prach: 34L Voda: 30L
Hlučnosť	60dB(A)
Rozmery	565×385×605
Hmotnosť	16,0kg
Dĺžka privádzajúceho kábla	7,5m

Dodávané s hadicou a nadstavcami na vysávanie

**VC4210L**  
**592,99 €**

**VC4210M**  
**644,99 €**

**Vysávač**

**VC3012L / VC3012M** /mokré & suché vysávanie/

325



EU trieda prašnosti	L / M
Príkon	1.500 W
Max. prietok vzduchu	3,7 m <sup>3</sup> /min
Max. podtlak	25,0kPa
Objem nádrže	Prach: 24L Voda: 19L
Hlučnosť	59dB(A)
Rozmery	450×380×595
Hmotnosť	11,0kg
Dĺžka privádzajúceho kábla	7,5m

Dodávané s hadicou a nadstavcami na vysávanie

**VC3012L**  
**432,99 €**

**VC3012M**  
**592,99 €**

**Vysávač**

**VC2000L**

325



EU trieda prašnosti	L
Príkon	1.000 W
Max. podtlak	21,0 kPa
Objem nádrže	20 L
Rozmery	390×385×505 mm
Hmotnosť	7,5 kg
Dĺžka privádzajúceho kábla	5 m

Dodávané s hadicou a nadstavcami na vysávanie



**VC2000L**  
**166,99 €**

**Vysávač**

**VC2012L / VC2512L / VC3011L** /mokré & suché vysávanie/

325



EU trieda prašnosti	L	L	L
Príkon	1.000 W	1.000 W	1.000 W
Max. prietok vzduchu	3,6 m <sup>3</sup> /min	3,6 m <sup>3</sup> /min	3,6 m <sup>3</sup> /min
Max. podtlak	21,0kPa	21,0kPa	21,0kPa
Objem nádrže	Prach: 15L Voda: 12L	Prach: 21L Voda: 18L	Prach: 26L Voda: 23L
Hlučnosť	72dB(A)	72dB(A)	72dB(A)
Rozmery	371×390×495	375×390×530	390×400×635
Hmotnosť	7,0 kg	7,0 kg	9,0kg
Dĺžka privádzajúceho kábla	7,5m	5 m	7,5m

Dodávané s hadicou a nadstavcami na vysávanie

**VC2012L**  
**269,99 €**

**VC2512L**  
**195,99 €**

**VC3011L**  
**279,99 €**

**Fukár**

**UB1103**

303



Príkon	600 W
Max. prietok vzduchu	0 – 4,1 m <sup>3</sup> /min
Max. rýchlosť vzduchu	0 – 91 m/s
Tlak vzduchu	0 – 5,7 kPa
Voľnobežné otáčky	0 – 16.000
Vúbracie	2,5 m/s <sup>2</sup>
Úroveň akustického tlaku	83 dB(A)
Úroveň akustického výkonu	94 dB(A)
Rozmery	479×185×178 mm
Hmotnosť	1,9 – 2,2 kg
Dĺžka privádzajúceho kábla	2,5 m









**UB1103**  
**88,99 €**



# ▣ PNEUMATICKÉ NÁRADIE / OSTATNÉ



-  Nastavenie hĺbky
-  Nastavenie dávkovania klincov
-  Postupné dávkovanie
-  Drôtom spájané klince
-  Páskou spájané klince
-  Tichý mód
-  Vnútorný filter
-  Automatické odstavenie spúšte
-  Prepravný kufrík





Prikon	1.800 W
Max. tlak v nádrži	2,8 MPa (410 PSI)
Max. pracovný tlak	Vysoký tlak: 2,6 MPa (375 PSI) Nízky tlak: 0,9 MPa (130 PSI)
Pracovný výkon	2,5 HP
Objem tlakovej nádrže	6,2 L
Max. prítok vzduchu	90 L/min
Rozmery	476×507×375 mm
Hmotnosť	36 – 37 kg



**AC310H**  
**1 299,99 €**



## Klincovačka

AN960



Dĺžka klincov	57 – 100 mm
Kapacita zásobníka	225 – 300
Pracovný tlak	0,49 – 0,83 MPa (71 – 120 PSI)
Rozmery	338x153x418 mm
Hmotnosť	5,1 kg



**AN960**  
748,99 €

## Klincovačka

AN902



Dĺžka klincov	45 – 90 mm
Kapacita zásobníka	150 – 300
Pracovný tlak	0,44 – 0,83 MPa (65 – 120 PSI)
Rozmery	408x131x316 mm
Hmotnosť	3,2 kg



**AN902**  
623,99 €

## Klincovačka

AN943



Dĺžka klincov	50 – 90 mm
Kapacita zásobníka	60 – 84
Pracovný tlak	0,44 – 0,83 MPa (65 – 120 PSI)
Rozmery	455x109x365 mm
Hmotnosť	4 kg



**AN943K**  
551,99 €

## Klincovačka

AN924



Dĺžka klincov	50 – 90 mm
Priemer klincov	2,9 – 3,76 mm
Uhol	21°
Kapacita zásobníka	64 – 73
Pracovný tlak	0,49 – 0,83 MPa (71 – 120 PSI)
Rozmery	560x117x348 mm
Hmotnosť	3,8 kg



**AN924**  
279,99 €

## Klincovačka na šindle

AN454



Dĺžka klincov	19 – 45 mm
Kapacita zásobníka	120
Pracovný tlak	0,49 – 0,83 MPa (71 – 120 PSI)
Rozmery	256x142x271 mm
Hmotnosť	2,4 kg



**AN454**  
231,99 €

## Spinkovačka

AT638A



Rozmer sponiek Dĺžka:	13 – 38 mm
Šírka:	5,7 mm
Kaliber:	18 Ga
Pracovný tlak	0,49 – 0,83 MPa (70 – 120 PSI)
Kapacita zásobníka	100
Rozmery	230×75×251 mm
Hmotnosť	1,2 kg

**AT638A**  
**129,99 €**

## Spinkovačka

AT2550A



Rozmer sponiek	Dĺžka: 25 – 50 mm
	Šírka: 25 mm
	Kaliber: 16 Ga
Pracovný tlak	0,44 – 0,83 MPa (65 – 120 PSI)
Kapacita zásobníka	140
Rozmery	370×76×260 mm
Hmotnosť	2,3 kg

**AT2550A**  
**467,99 €**

## Spinkovačka

AT1150A



Rozmer sponiek	Dĺžka: 25 – 50 mm
	Šírka: 11 mm
	Kaliber: 16 Ga
Pracovný tlak	0,44 – 0,83 MPa (65 – 120 PSI)
Kapacita zásobníka	140
Rozmery	370×87×290 mm
Hmotnosť	2,3 kg

**AT1150A**  
**384,99 €**

## Klincovačka /piniky/

AF353



Dĺžka klincov /piniek/	15 – 35 mm
Typ klincov	23 Ga
Kapacita zásobníka	130
Pracovný tlak	0,45 – 0,69 MPa (65 – 100 PSI)
Rozmery	208×66×191 mm
Hmotnosť	0,9 kg

**AF353**  
**129,99 €**

## Klincovačka

AF506



Dĺžka klincov	15 – 50 mm
Kapacita zásobníka	100
Pracovný tlak	0,49 – 0,83 MPa (71 – 120 PSI)
Rozmery	250×70×256 mm
Hmotnosť	1,3 kg

**AF506**  
**109,99 €**



## Teplovzdušná pištoľ

HG5030K



Príkon	1.600 W
Teplota vzduchu	350 – 500 °C
Max. prietok vzduchu	300 – 500 L/min
Hmotnosť	0,56 kg
Dĺžka privodného kábla	2,0 m
Displej	nie

**HG5030K**  
**77,99 €**

## Teplovzdušná pištoľ

HG6030K



Príkon	1.800 W
Teplota vzduchu	50 / 300 / 600 °C
Max. prietok vzduchu	250 / 250 / 500 L/min
Rozmery	233x80x208 mm
Hmotnosť	0,57 kg
Dĺžka privodného kábla	2,0 m
Displej	nie

**HG6030K**  
**93,99 €**

## Teplovzdušná pištoľ

HG6031VK



Príkon	1.800 W
Teplota vzduchu	50 – 600 °C
Max. prietok vzduchu	250 – 500 L/min
Hmotnosť	0,67 kg
Dĺžka privodného kábla	2,0 m
Displej	nie

**HG6031VK**  
**104,99 €**

## Teplovzdušná pištoľ

HG6530VK



Príkon	2.000 W
Teplota vzduchu	50 – 650 °C
Max. prietok vzduchu	500 / 280 / 550 L/min
Rozmery	257x85x206 mm
Hmotnosť	0,72 kg
Dĺžka privodného kábla	2,0 m
Displej	áno

**HG6530VK**  
**129,99 €**

## Teplovzdušná pištoľ

HG6531CK



Príkon	2.000 W
Teplota vzduchu	50 – 650 °C
Max. prietok vzduchu	200 – 550 L/min
Hmotnosť	0,72 kg
Dĺžka privodného kábla	2,0 m
Displej	áno

**HG6531CK**  
**163,99 €**



Presnosť merania	±1 mm / 10 m
Samonivelizácia	±2°
Uhol lasera	Horizontal: 110° Vertical: 130°
Počet laserových línií	3
Typ lasera	Laser class 2: 515 nm
Pracovná teplota	-10 – 40 °C
Uchytenie statívu	5/8"
Trieda ochrany	IP54
Pracovný čas cca	10-28
Rozmery	s BL1016/BL1021B: 122×110×225 mm s BL1041B: 122×130×225 mm
Hmotnosť	1,5 – 1,6 kg

**CXT XPT**  
EXTREME PROTECTION TECHNOLOGY

**SK312GDZ**  
**1 559,99 €**



Max. dosah merania	do 25 m
Max. dosah merania s detektorom	do 80 m
Presnosť merania	±3 mm / 10 m
Samonivelizácia	4+ - °
Počet laserových bodov	4
Počet laserových línií	2
Uhol laserových línií	Horizont 180° / vertikál 170°
Typ lasera	Trieda lasera 2: 635 nm
Pracovná teplota	-10 až 50 °C
Pracovný čas	15 – 40 hod
Rozmery	138×64×102 mm
Hmotnosť	0,69 – 0,85 kg

**CXT XPT**  
EXTREME PROTECTION TECHNOLOGY

**SK106DZ**  
**346,99 €**



Max. dosah merania	do 25 m
Max. dosah merania s detektorom	do 80 m
Presnosť merania	±3 mm / 10 m
Samonivelizácia	4+ - °
Počet laserových línií	2
Uhol laserových línií	Horizont 180° / vertikál 160°
Typ lasera	Trieda lasera 2: 635 nm
Pracovná teplota	-10 až 50 °C
Pracovný čas	15 – 40 hod
Rozmery	138×64×102 mm
Hmotnosť	0,67 – 0,84 kg

**CXT XPT**  
EXTREME PROTECTION TECHNOLOGY

**SK105DZ**  
**205,99 €**

NOVINKA



Presnosť merania	± 1 mm / 10 m
Samonivelizácia	± 4°
Uhol lasera	Horizontal: 110° Vertical: 130°
Počet laserových línií	4V1H / 2V1H / 1V1H
Typ lasera	2: 515 nm
Pracovná teplota	-10 – 40 °C
Uchytenie statívu	-
Trieda ochrany	IP54
Pracovný čas cca	6 hodín
Rozmery	Ø 98×223 mm
Hmotnosť	1,4 – 1,6 kg

**CXT XPT**  
EXTREME PROTECTION TECHNOLOGY

**SK40GD**  
**973,99 €**

NOVINKA



Presnosť merania	± 2 mm / 10 m
Samonivelizácia	± 4°
Typ lasera	2: 510 – 530 nm
Pracovná teplota	-10 – 50 °C
Trieda ochrany	IP54
Rozmery	149×104×153 mm
Hmotnosť	0,99 – 1,2 kg

G – zelený laser

**CXT XPT**  
EXTREME PROTECTION TECHNOLOGY



**SK700D**  
**467,99 €**

**SK700GD**  
**699,99 €**

## Samonivelizačný laser

SKR200Z



Max. dosah merania (priemer)	200 m
Rýchlosť otáčok	0, 300, 450, 600
Presnosť merania	±1 mm / 10 m
Samonivelizácia	±6°
Napájanie	2×1,5 Ah aku
Max. pracovný čas	60 hod.
Hmotnosť	1,6 kg

**SKR200Z**  
865,99 €

## Laserový diaľkomer

LD080PI



Max. dosah merania	0,05 – 80 m
Napájanie	2×AAA 1,5 V aku
Hmotnosť	0,14 kg

**LD080PI**  
216,99 €

## Laserový diaľkomer

LD050P



Max. dosah merania	0,05 – 50 m
Napájanie	2×AAA 1,5 V aku
Hmotnosť	0,1 kg

**LD050P**  
108,99 €

## Laserový diaľkomer

LD030P



Max. dosah merania	0,2 – 30 m
Pracovná teplota	0 – 40 °C
Skladovacia teplota	-25 – 70 °C
Priemerná presnosť merania	±2,0 mm / 10 m
Max. presnosť merania	±3,0 mm / 10 m
Priemer laserového bodu	6 mm / 10 m
Typ laseru	Trieda laseru 2: 635 nm
Rozmery	117×53×25 mm
Hmotnosť	0,1 kg

**LD030P**  
75,99 €



# ▣ ZÁHRADA



-  Dvojitá izolácia
-  Regulácia otáčok
-  Brzda
-  Spätňý chod
-  2 rýchlosti
-  3 rýchlosti
-  Konštantná rýchlosť
-  Plynulý rozbeh

## Elektrická kosačka

ELM3320



Príkon	1.200 W
Motor	Univerzálny
Šírka záberu	330 mm
Sasi	plast
Uloženie kolies	klzné ložisko
Nastavenie výšky kosenia	20 – 55 mm
Pohon kolies	nie
Objem zberného koša	30 L
Hmotnosť	10,2 kg

**ELM3320**  
**186,99 €**

## Elektrická kosačka

ELM3720



Príkon	1.400 W
Motor	Univerzálny
Šírka záberu	370 mm
Sasi	plast
Uloženie kolies	klzné ložisko
Nastavenie výšky kosenia	20 – 55 mm
Pohon kolies	nie
Objem zberného koša	40 L
Hmotnosť	11,6 kg

**ELM3720**  
**212,99 €**

## Elektrická kosačka

ELM4120



Príkon	1.600 W
Motor	Univerzálny
Šírka záberu	410 mm
Sasi	plast
Uloženie kolies	guličkové ložisko
Nastavenie výšky kosenia	20 – 75 mm
Pohon kolies	nie
Objem zberného koša	45 L
Hmotnosť	14,5 kg

**ELM4120**  
**272,99 €**

## Elektrická kosačka

ELM4121



Príkon	1.600 W
Motor	Univerzálny
Šírka záberu	410 mm
Sasi	ocel
Uloženie kolies	guličkové ložisko
Nastavenie výšky kosenia	20 – 75 mm
Pohon kolies	nie
Objem zberného koša	60 L
Hmotnosť	19 kg

**ELM4121**  
**329,99 €**

## Elektrická kosačka

ELM4620



Príkon	1.800 W
Motor	Indukčný
Šírka záberu	460 mm
Sasi	ocel
Uloženie kolies	guličkové ložisko
Nastavenie výšky kosenia	20 – 75 mm
Pohon kolies	nie
Objem zberného koša	60 L
Hmotnosť	23,4 kg

**ELM4620**  
**455,99 €**



Prikon	1.800 W
Motor	Indukčný
Šírka záberu	460 mm
Sasi	oceľ
Uloženie kolies	guličkové ložisko
Nastavenie výšky kosenia	20 - 75 mm
Pohon kolies	áno
Objem zberného koša	60 L
Hmotnosť	32,1 kg

**ELM4621**  
**488,99 €**



Prikon	1.300 W
Šírka záberu	320 mm
Nastavenie výšky kosenia	5 stupňové (-10, -5, 0, +5, +10 mm)
Objem zberného koša	30 L
Hmotnosť	10,5 kg

**UV3200**  
**228,99 €**



Prikon	1.800 W
Šírka záberu	370 mm
Nastavenie výšky kosenia	4 stupňové (-10, -5, 0, +5 mm)
Objem zberného koša	40 L
Hmotnosť	15,7 kg

**UV3600**  
**325,99 €**



Prikon	2.000 W
Rýchlosť režaze /min/	870m
Dĺžka lišty	UC3051A: 300mm UC3551A: 350mm UC4051A: 400mm
Delenie reťaze / šírka drážky	3/8" / 1,3mm
Úroveň akustického tlaku / akustického výkonu	90,8dB(A) / 101,8dB(A)
Vibrácie	5,2m/s <sup>2</sup>
Rozmery	505x200x220mm
Hmotnosť	UC3051A: 5,4 - 5,7 kg UC3551A: 5,5kg UC4051A: 5,6kg
Dĺžka privodného kábla	0,3m



**UC3051AX1**  
**249,99 €**

**UC3551AX1**  
**259,99 €**

**UC4051AX1**  
**269,99 €**

X1 - 2 reťaze



Prikon	1.800 W
Rýchlosť režaze /min/	870m
Dĺžka lišty	UC3041A: 300mm UC3541A: 350mm UC4041A: 400mm
Delenie reťaze / šírka drážky	3/8" / 1,1mm
Úroveň akustického tlaku / akustického výkonu	90,3dB(A) / 101,3dB(A)
Vibrácie	4,7 m/s <sup>2</sup>
Rozmery	455x245x200mm
Hmotnosť	UC3041A: 4,6 - 4,7 kg UC3541A: 4,7 - 4,8 kg UC4041A: 4,8 - 4,9 kg
Dĺžka privodného kábla	0,3m



**UC3041A**  
**153,99 €**

**UC3541A**  
**164,99 €**

**UC4041A**  
**173,99 €**



## Elektrický vyžinač

UR3000



Príkon	450 W
Sírka záberu	300 mm
Voľnobežné otáčky	9.000 / min
Rozmery	1.016-1.256x301x262 mm
Hmotnosť	2,6 kg
Dĺžka privodného kábla	0,3 m



**UR3000**  
**113,99 €**

## Elektrický vyžinač

UR3501



Príkon	1.000 W
Sírka záberu	350 mm
Voľnobežné otáčky	7.500 / min
Rozmery	1.550x410x500 mm
Hmotnosť	4,3 kg
Dĺžka privodného kábla	0,3 m



**UR3501**  
**153,99 €**

## Elektrický vyžinač

UR3502



Príkon	1.000 W
Sírka záberu	350 mm
Voľnobežné otáčky	6.500 / min
Rozmery	1.630x380x300 mm
Hmotnosť	4,9 kg
Dĺžka privodného kábla	0,3 m



**UR3502**  
**159,99 €**

## Elektrický drvič

UD2500



Príkon	2.500 W
Max. rezný výkon	45 mm
Objem zbernej nádoby	67 L
Voľnobežné otáčky	40 / min
Rozmery	650x500x850 mm
Hmotnosť	29,7 kg



**UD2500**  
**389,99 €**

## Elektrický plotostrih

UH4861



Príkon	400 W
Dĺžka noža	480 mm
Počet strihov	3.200
Rozmery	871x 194 x 194 mm
Hmotnosť	3 kg
Dĺžka privodného kábla	0,3 m



**UH4861**  
**147,99 €**

## Elektrický plotostrih

UH5261



Příkon	400 W
Délka nože	520 mm
Počet stříhův	3.200
Rozměry	921x 194 x 194 mm
Hmotnost	3 kg
Délka přívodního kábla	0,3 m



**UH5261**  
**152,99 €**

## Elektrický plotostrih

UH5570



Příkon	550 W
Délka nože	550 mm
Počet stříhův	1.600 / min
Max. rezný výkon	21 mm
Rozměry	970x223x206 mm
Hmotnost	3,7 kg
Délka přívodního kábla	0,3 m



**UH5570**  
**152,99 €**

## Elektrický plotostrih

UH6570



Příkon	550 W
Délka nože	650 mm
Počet stříhův	1.600 / min
Max. rezný výkon	21 mm
Rozměry	1.042x223x206 mm
Hmotnost	3,8 kg
Délka přívodního kábla	0,3 m



**UH6570**  
**162,99 €**

## Elektrický plotostrih

UH6580



Příkon	670 W
Délka nože	650 mm
Počet stříhův	1.500 / min
Max. rezný výkon	21 mm
Rozměry	1 042x223x206mm
Hmotnost	4,3 kg
Délka přívodního kábla	0,3 m



**UH6580**  
**228,99 €**

## Elektrický plotostrih

UH7580



Příkon	670 W
Délka nože	750 mm
Počet stříhův	1.500 / min
Max. rezný výkon	21 mm
Rozměry	1.157x223x206 mm
Hmotnost	4,6 kg
Délka přívodního kábla	0,3 m



**UH7580**  
**249,99 €**

## Vysokotlakový čistič

HW1200



Príkon	1.800 W
Max. tlak	12 MPa (120 bar. 1.740 PSI)
Max. prietok vody	420 L/h
Max. teplota privádzanej vody	40 °C
Dĺžka vysokotlakovej hadice	10 m
Úroveň akustického tlaku	72 dB(A)
Vibrácie	4,11 m/s <sup>2</sup>
Rozmery	292x358x830 mm
Hmotnosť	11,0 kg
Dĺžka privodného kábla	5,0 m



**HW1200**  
**341,99 €**

## Vysokotlakový čistič

HW1300

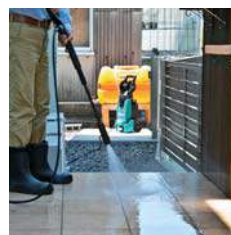

Príkon	1.800 W
Max. tlak	13 MPa (130 bar. 1.885 PSI)
Max. prietok vody	420 L/h
Max. teplota privádzanej vody	40 °C
Dĺžka vysokotlakovej hadice	10 m
Úroveň akustického tlaku	76 dB(A)
Vibrácie	4,86 m/s <sup>2</sup>
Rozmery	292x358x830 mm
Hmotnosť	12,7 kg
Dĺžka privodného kábla	5,0 m



**HW1300**  
**419,99 €**

## Vysokotlakový čistič

HW102 / HW111 / HW132 / HW151



	HW102	HW111	HW132	HW151
Príkon	1.300 W	1.700 W	2.100 W	2.500 W
Max. tlak	10 MPa (100 bar. 1.450 PSI)	11 MPa (110 bar. 1.595 PSI)	14 MPa (140 bar)	15 MPa (150 bar. 2.175 PSI)
Max. prietok vody	360 L/hr	370 L/hr	420 L/hr	500 L/hr
Typ motora	Univerzálny	Univerzálny	Indukčný	Indukčný
Úroveň akustického tlaku	85,74 dB(A)	79,15 dB(A)	80,1 dB(A)	80,1 dB(A)
Úroveň akustického výkonu	94 dB(A)	87 dB(A)	88 dB(A)	88 dB(A)
Max. teplota privádzanej vody	50 °C	50 °C	50 °C	50 °C
Dĺžka vysokotlakovej hadice	5 m	5,5 m	8 m	10 m
Hmotnosť	5,8 kg	7,4 kg	18,8 kg	26,9 kg

**HW102**  
**129,99 €**

**HW111**  
**216,99 €**

**HW132**  
**378,99 €**

**HW151**  
**724,99 €**

## Ponorné čerpadlá

PF0300 / PF0410 / PF0800 / PF1010



	PF0300	PF0410	PF0800	PF1010
Príkon	300 W	400 W	800 W	1.100 W
Max. prietok	140 L	140 L	220 L	240 L
Max. výtlak	7 m	5 m	9 m	10 m
Max. hĺbka ponoru	5 m	5 m	5 m	5 m
Max. výtlak	7 m	5 m	9 m	10 m
Min. sacia hĺbka	20 mm	40 mm	20 mm	40 mm
Max. veľkosť nečistôt	5 mm	35 mm	5 mm	35 mm
Rozmery	160x168x305	160x168x345	160x168x340	160x168x380
Hmotnosť	4,2 kg	4,3 kg	6,1 kg	6,6 kg
Dĺžka privodného kábla	10 m	10 m	10 m	10 m

**PF0300**  
**75,99 €**

**PF0410**  
**75,99 €**

**PF0800**  
**98,99 €**

**PF1010**  
**119,99 €**



## ▣ SETY NÁRADIA



**DLX2153TJ1**DGA504Z + DHR241Z +  
2 ks 5,0 Ah + DC18RDLX2153TJ1  
648,99 €**MEU029J**SP6000 + 4351FCT +  
kuforMEU029J  
648,99 €**DLX2349J**DDF485Z + DML815 +  
3 ks BL1830 + DC18RC +  
systainerDLX2349J  
415,99 €**Set**DDF485RFJ +  
632G12-3 (18 V, 3,0 Ah)DDF485RFJ + 632G12-3  
319,99 €**DLX3078TX1**DGA504Z + DHR241Z +  
DDF482Z + 3 ks 5,0 Ah +  
DC18RC + taškaDLX3078TX1  
865,99 €**Set**

DHP485RFJ + DTD171Z

DHP485RFJ + DTD171Z  
449,99 €**DK0053G**GA9020 + 9558HNRG +  
kuforDK0053G  
238,99 €**Set**DCL180Z + 195584-2 +  
632F01-2DCL180Z + 195584-2 + 632F01-2  
169,99 €**Set**

KP0800 + 824892-1

KP0800 + 824892-1  
169,99 €**Set**

DDF453RFE+DCL180Z

DDF453RFE + DLC180Z  
269,99 €



DLX2153TJ1 +  
TR00000001

DLX2153TJ1 + TR00000001  
699,99 €



HS6601J + 197462-2 +  
199141-8

HS6601J + 197462-2 + 199141-8  
199,99 €



HR5212C + DMR108N

HR5212C + DMR108N  
1 179,99 €



SG150 + VC4210L

SG150 + VC4210L  
1 399,99 €



DF333DSAE + CL108FDZ

DF333DSAE + CL108FDZ  
209,99 €



DBM230 + P-54190

DBM230 + P-54190  
2 399,99 €



HR2630 + GA5030R

HR2630 + GA5030R  
229,99 €



LS1018LN + DEAWST07

LS1018LN + DEAWST07  
769,99 €



HR2630T + GA9060R

HR2630T + GA9060R  
369,99 €

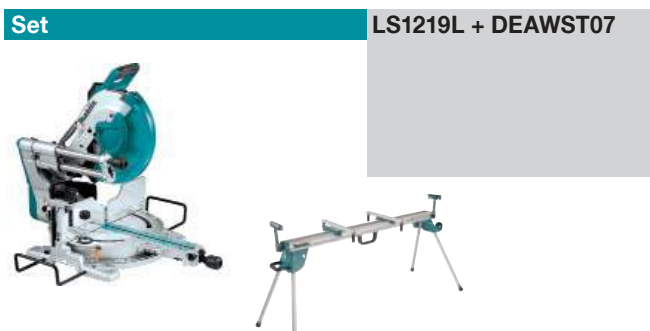

LS1219L + DEAWST07

LS1219L + DEAWST07  
1 199,99 €



# Makita<sup>®</sup>

## imt



## Vrtačka

M6002 10 mm



Prikon	450 W
Max. vrtací výkon	železo: 10 mm drevo: 25 mm
Voľnobežné otáčky	0-3.000 min <sup>-1</sup>
Rozmery	234×64×175 mm
Hmotnosť	1,3 kg
Dĺžka privodného kábla	2,0 m
Rozsah upínania skľučovadla	0,8-10 mm

**M6002**  
**51,99 €**

## Miešadlo

M6600



Prikon	800 W
Voľnobežné otáčky	0-700 min <sup>-1</sup>
Uchytenie nástroja	M12 alebo M14
Rozmery	280×86×388 mm
Hmotnosť	3,4 kg
Dĺžka privodného kábla	2,0 m

**M6600**  
**108,99 €**

## Príklepová vrtačka

M8103 13 mm



Prikon	430 W
Max. vrtací výkon	betón: 13 mm železo: 13 mm drevo: 18 mm
Voľnobežné otáčky	0-3.000 min <sup>-1</sup>
Frekvencia príklepu	0-33.000 min <sup>-1</sup>
Rozmery	255×72×193 mm
Hmotnosť	1,8 kg
Dĺžka privodného kábla	2,0 m

**M8103**  
**65,99 €**
**M8103KX2**  
**103,99 €**

KX2 – 26 dielna sada príslušenstva

## Kombinované kladivo SDS Plus

M8700 22 mm



Prikon	710 W
Max. vrtací výkon	betón: 22 mm železo: 13 mm drevo: 32 mm
Frekvencia príklepu	0-4.350
Voľnobežné otáčky	0-1.100 min <sup>-1</sup>
Rozmery	362×71×194 mm
Hmotnosť	2,5 kg
Dĺžka privodného kábla	5,0 m

**M8700**  
**119,99 €**

## Kombinované kladivo SDS Plus

M8701Z



Prikon	800 W
Síla jednotlivého príklepu	EPTA-Procedure 05/2009 : 2,3 J
Max. vrtací výkon betón	betón: 26 mm
Max. vrtací výkon železo	železo: 13 mm
Max. vrtací výkon drevo	drevo: 32 mm
Frekvencia príklepu	0-4.500
Voľnobežné otáčky	0-1.200 min <sup>-1</sup>
Rozmery	362×71×194 mm
Hmotnosť	2,7 kg
Dĺžka privodného kábla	5,0 m

**M8701Z**  
**129,99 €**



## Uhlová brúska

M9502R 115 mm



Príkon	570 W
Priemer kotúča Ø	115 mm
Voľnobežné otáčky	11.000 min <sup>-1</sup>
Rozmery	281×130×110 mm
Hmotnosť	2,0 kg
Dĺžka privodného kábla	2,0 m

**M9502R**  
**69,99 €**

## Uhlová brúska

M9503R 125 mm



Príkon	570 W
Priemer kotúča Ø	125 mm
Voľnobežné otáčky	11.000 min <sup>-1</sup>
Rozmery	281×140×110 mm
Hmotnosť	2,1 kg
Dĺžka privodného kábla	2,0 m

**M9503R**  
**71,99 €**

## Uhlová brúska

M9001 230 mm



Príkon	2.000 W
Rozmer brúsneho pásu	230 mm
Rýchlosť brúsneho pásu	6.600 min <sup>-1</sup>
Rozmery	466×250×138 mm
Hmotnosť	5,7 kg
Dĺžka privodného kábla	2,0 m

**M9001**  
**124,99 €**

## Pásová brúska

M9400 100 mm



Príkon	940 W
Rozmer brúsneho pásu	100×610 mm
Rýchlosť brúsneho pásu	380 m/min.
Rozmery	354×175×169 mm
Hmotnosť	6,2 kg
Dĺžka privodného kábla	2,0 m

**M9400**  
**175,99 €**

## Excentrická brúska

M9204 125 mm



Príkon	240 W
Priemer brúsnej plochy	123 mm
Priemer brúsneho papiera	125 mm
Voľnobežné otáčky za min.	12.000
Počet kmitov za minútu	24.000
Priemer okruhu	2,8 mm
Rozmery	153×123×144 mm
Hmotnosť	1,2 kg
Dĺžka privodného kábla	2,0 m

**M9204**  
**69,99 €**



## Vibračná brúska

M9203



Prikon	190 W
Priemer brúsnej plochy	92×185 mm
Priemer brúsneho papiera	93×228 mm
Voľnobežné otáčky za min.	12.000
Počet kmitov za minútu	24.000
Priemer okruhu	2,0 mm
Rozmery	252×92×154 mm
Hmotnosť	1,4 kg
Dĺžka prívodného kábla	2,0 m



**M9203**  
**69,99 €**

## Rezačka na železo 355 mm

M2401



Prikon	2.000 W
Priemer kotúča	355 mm
Vrtanie kotúča	25,4 mm
Max. hrúbka kotúča	3 mm
Voľnobežné otáčky	3.900 min <sup>-1</sup>
Hmotnosť	15,3 kg
Dĺžka prívodného kábla	2,5 m



**M2401**  
**206,99 €**

## Rezačka na železo 355 mm

M2402

**NOVINKA**



Prikon	2.200 W
Priemer kotúča	355 mm
Vrtanie kotúča	25,4 mm
Max. hrúbka kotúča	3 mm
Voľnobežné otáčky	3.800
Hmotnosť	14,5 kg
Dĺžka prívodného kábla	2,0 m



**M2402**  
**228,99 €**

## Kotúčová píla

M5802 190 mm, 185 mm



Prikon	1.050 W
Priemer kotúča	190 / 185 mm
Max. rezný výkon	pri 90°: 68 / 66 mm pri 45°: 46 / 44 mm
Voľnobežné otáčky	4.900 min <sup>-1</sup>
Celková dĺžka	297 mm
Hmotnosť	4,0 kg
Dĺžka prívodného kábla	2,0 m



**M5802**  
**126,99 €**

## Priamočiara píla

M4301



Prikon	450 W
Max. rezný výkon	drevo: 65 mm železo: 6 mm
Dĺžka zdvihu	18 mm
Počet zdvihov za minútu	0-3.100
Rozmery	214×75×202 mm
Hmotnosť	1,9 kg
Dĺžka prívodného kábla	2,0 m



**M4301**  
**68,99 €**

## Chvostová píla

M4501K



Príkon	1.010 W
Dĺžka zdvíhu	28 mm
Počet zdvihov za minútu	0-2.800
Max. rezný výkon	rúra: 130 mm
	drevo: 255 mm
Rozmery	457x98x170 mm
Hmotnosť	3,2 kg
Dĺžka privodného kábla	2,0 m

**M4501K**  
**141,99 €**

## Chvostová píla

M4500K



Príkon	1.010 W
Dĺžka zdvíhu	28 mm
Počet zdvihov za minútu	0-2.800
Max. rezný výkon	rúra: 130 mm
	drevo: 255 mm
Rozmery	457x98x174 mm
Hmotnosť	3,1 kg
Dĺžka privodného kábla	2,0 m

**M4500K**  
**127,99 €**

X2 – brúsny papier 60,80,120, pad, rezný nástroj

## Multifunkčné náradie

M9800X2



Príkon	200 W
Počet strihov za minútu	15.000 – 22.000
Hmotnosť	1,2 – 1,3 kg
Dĺžka privodného kábla	2 m

**M9800X2**  
**129,99 €**

## Jednoručná fréza

M3702

NOVINKA



Príkon	530 W
Voľnobežné otáčky	35.000 / min
Upínacia klieština	6 mm
Rozmery	82x90x211 mm
Hmotnosť	1,5 kg
Dĺžka privodného kábla	2 m

**M3702**  
**93,99 €**

## Horná fréza so zanorením

M3601 6 mm, 8 mm



Príkon	900 W
Upínacia klieština	6 mm, 8 mm (dodávané so 6 mm klieštinou)
Max. zanorenie	0-35 mm
Voľnobežné otáčky	27.000 min <sup>-1</sup>
Celková výška	256 mm
Hmotnosť	2,7 kg
Dĺžka privodného kábla	2,0 m

**M3601**  
**99,99 €**

## Horná fréza so zanorením

M3602 6 mm, 8 mm

**NOVINKA**



Príkon	1 650 W
Voľnobežné otáčky	22 000 / min
Upínacia klieština	12 mm
Rozmery	148x284x300 mm
Hmotnosť	5,7 kg
Dĺžka prívodného kábla	2 m



**M3602**  
197,99 €

## Hoblík

M1902 82 mm



Príkon	500 W
Šírka záberu	82 mm
Hrúbka triesky	1 mm
Hĺbka drážky	9 mm
Voľnobežné otáčky	16.000 min <sup>-1</sup>
Rozmery	285x157x160 mm
Hmotnosť	2,7 kg
Dĺžka prívodného kábla	2,0 m



**M1902**  
88,99 €

## Hoblík

M1901 82 mm



Príkon	500 W
Šírka záberu	82 mm
Hrúbka triesky	2 mm
Hĺbka drážky	9 mm
Voľnobežné otáčky	16.000 min <sup>-1</sup>
Celková dĺžka	285 mm
Hmotnosť	2,7 kg
Dĺžka prívodného kábla	2,0 m



**M1901**  
103,99 €

## Kompatibilita akumulátorov pre rádiá

Model	Bluetooth	DAB+	DAB	Made for iPod iPhone	USB	LXT		CXT		18V G Li-ion	14.4V G Li-ion	18V-9.6V Ni-MH/Ni-Cd
						18V Li-ion	14.4V Li-ion	12Vmax Li-ion	10.8V Li-ion			
DMR112	✓	✓	✓		✓	✓	—	✓	✓	✓	—	—
DMR110		✓	✓			✓	✓	✓	✓	✓	—	—
DMR109			✓			✓	✓	✓	✓	✓	—	—
DMR108	✓					✓	✓	✓	✓	✓	—	—
DMR107						✓	✓	✓	✓	✓	—	—
DMR106	✓					✓	✓	—	✓	✓	✓	—
DMR050						✓	✓	—	—	—	—	—
DMR052						—	—	✓	—	—	—	—
DMR200	✓					✓	✓	✓	—	—	—	—
DMR201	✓				✓	✓	✓	✓	—	—	—	—
DMR202	✓				✓	✓	✓	✓	—	—	—	—



























## VYSVETLIVKY

### 18 V / 12 V MAX program

- Z – dodávané bez akumulátora a nabíjačky
- J – dodávané v systainery
- K – dodávané v kufri
- X – extra príbal príslušenstva
- PT2 – Dvojnabíjačka /rýchlonabíjačka/, 2 ks 5,0 Ah akumulátor
- PT4 – Dvojnabíjačka /rýchlonabíjačka/, 4 ks 5,0 Ah akumulátor
- PF2 – Rýchlonabíjačka, 2 ks 3,0 Ah akumulátor
- RF – Rýchlonabíjačka, 1 ks 3,0 Ah akumulátor
- SYE – Nabíjačka, 2 ks 1,5 Ah akumulátor
- RFJ – Rýchlonabíjačka, 2 ks 3,0 Ah akumulátor, systainer
- RFE – Rýchlonabíjačka, 2 ks 3,0 Ah akumulátor
- RTE – Rýchlonabíjačka, 2 ks 5,0 Ah akumulátor
- RTJ – Rýchlonabíjačka, 2 ks 5,0 Ah akumulátor, systainer
- RF3J – Rýchlonabíjačka, 3 ks 3,0 Ah akumulátor, systainer
- RFEB – Rýchlonabíjačka, 2 ks 3,0 Ah akumulátor, čierne prevedenie stroja
- RTJV – Rýchlonabíjačka, 2 ks 5,0 Ah akumulátor, systainer, odsávacie zariadenie
- DZ – dodávané bez akumulátora a nabíjačky
- DSAE – Rýchlonabíjačka, 2 ks 2,0 Ah akumulátor
- DSME – Rýchlonabíjačka, 2 ks 4,0 Ah akumulátor

### 40 V program

- GD101 – Rýchlonabíjačka, 1 ks 2,5 Ah akumulátor
- GM101 – Rýchlonabíjačka, 1 ks 4,0 Ah akumulátor
- GT101 – Rýchlonabíjačka, 1 ks 5,0 Ah akumulátor
- GZ – dodávané bez akumulátora a nabíjačky
- GD201 – Rýchlonabíjačka, 2 ks 2,5 Ah akumulátor
- GM201 – Rýchlonabíjačka, 2 ks 4,0 Ah akumulátor
- GT201 – Rýchlonabíjačka, 2 ks 5,0 Ah akumulátor

### Označenie akumulátorov 12 / 14,4 / 18 V

- Y – 1,5 Ah
- A – 2,0 Ah
- F – 3,0 Ah
- M – 4,0 Ah
- T – 5,0 Ah
- G – 6,0 Ah



- A – 2,0 Ah
- D – 2,5 Ah
- M – 4,0 Ah
- T – 5,0 Ah

**ADT**

– Automatická regulácia otáčok

**AFT**

– Automatické zastavenie stroja

**DXT**

– presný rez

**XPT**  
EXTREME PROTECTION TECHNOLOGY

– ochrana proti zvýšenej  
prašnosti a vlhkosti

**SJST**  
SUPER JOINT SYSTEM

– antivibračný systém

**AWS**

– prepojenie aku strojov  
s aku vysávačom

**AVT**

– antivibračný systém

ANTI VIBRATION TECHNOLOGY  
**BL**  
MOTOR

– bezuhlíkový motor



– brzda

## Katalóg strojov Makita



**Makita s. r. o.**  
Priemyselná 26, 974 01 Banská Bystrica  
[www.makita.sk](http://www.makita.sk)



**LXI CXI MM4**  
RoHS REACH